



CAPACITIVE LEVEL METERS DLM-35



CONTENTS

1. Basic description	4
2. Variants of level meters.....	5
3. Dimensional drawing.....	6
4. Installation and putting into operation	8
5. Installation instructions.....	8
6. Electrical connection	10
7. Control elements	11
8. Function and status indication.....	11
9. Settings	12
10. Order code	14
11. Correct specification examples	14
12. Accessories.....	15
13. Safety, protections, compatibility and explosion proof	15
14. Use, manipulation and maintenance.....	16
15. General, conditions and warranty	16
16. Marking of labels.....	16
17. Technical specifications.....	19
18. Packings, shipping and storage	23

USED SYMBOLS

To ensure maximum safety of control processes, we have defined the following safety instructions and information. Each instruction is labelled with the appropriate pictogram.



Alert, warning, danger

This symbol informs you about particularly important instructions for installation and operation of equipment or dangerous situations that may occur during the installation and operation. Not observing these instructions may cause disturbance, damage or destruction of equipment or may cause injury.



Information

This symbol indicates particularly important characteristics of the device.



Note

This symbol indicates helpful additional information.

SAFETY



All operations described in this instruction manual have to be carried out by trained personnel or by an accredited person only. Warranty and post warranty service must be exclusively carried out by the manufacturer.

Improper use, installation or set-up of the sensor can lead to crashes in the application.

The manufacturer is not responsible for improper use, loss of work caused by either direct or indirect damage, and for expenses incurred at the time of installation or during the period of use of the level sensors.

1. BASIC DESCRIPTION

The **capacitive level meters DLM®** are intended for continuous level measurement of liquid and bulk solids in tanks, vessels, sumps or silos, hoppers etc. They are comprised of a housing with electronic module and measuring electrodes. The electronic part converts the size of the capacity to the current signal (4 ... 20 mA) or voltage signal (0 ... 10 V). Level meters are made in several modifications of measuring electrodes (rod and rope). The electrodes can be covered by an insulating coating in case level measurement of adhesive, aggressive or electrically conductive media. Rod electrodes are also available in a version with reference (coaxial) tube for level measurement of liquids in tanks made from non-conductive material.

Level meters are produced in the following performances: **N** – for non-explosive areas, **NT** – high temperature for non-explosive areas, **Xi** – Explosion proof – intrinsically safe for hazardous (explosive) areas and **XiM** – Explosion proof – intrinsically safe for use in mines with methane or flammable dust presence danger (see technical specifications). There are high temperature performance **NT**, **XiT**, **XiMT** available. DLM are offered in variants with various types of process connection (metric and pipe thread, pressure thread NPT).

2. VARIANTS OF LEVEL METERS

- **DLM-35_-20 Uncoated rod electrode** for level measurement of bulk-solids (cement, flour, sand, plastic granulate) and electrically non-conductive liquids (vegetable oil, diesel fuel, petrol).
Maximum electrode length 2 m.
- **DLM-35_-21 Coated rod electrode (insulation FEP)** for level measurement of water and other electrically conductive liquids. Can also be used for polluted liquids in metal tanks, concrete sumps, etc.
Maximum electrode length 2 m.
- **DLM-35_-22 Coated rod electrode (insulation PFA)** with enhanced resistance to permeation (diffusion) of vapours and gases. For level measurement of water and other electrically conductive liquids in the food, pharmaceutical and chemical industries. In the short term can be used for high temperature applications (e.g. hot steam sanitation), or for volatile aggressive liquids, etc.
Maximum electrode length 2 m.
- **DLM-35_-25** like DLM-35_-21 but higher pressure resistance at high temperature. Suitable for high temperature applications (hot steam) etc.
Maximum electrode length 2 m.
- **DLM-35_-30 Uncoated rod electrode** used for level measurement of bulk-solids (cement, flour, sand, plastic granulate) and electrically non-conductive liquids (vegetable oil, diesel fuel, petrol).
Maximum electrode length 3 m.
- **DLM-35_-31 Coated rod electrode (FEP)** for level measurement of water and other electrically conductive liquids. Can also be used for polluted liquids in metal tanks, concrete sumps, etc.
Maximum electrode length 3 m.
- **DLM-35_-40 Uncoated rod electrode with reference tube (coaxial electrode)** for accurate level measurement of unpolluted electrically non-conductive liquids (oils, diesel fuel, petrol). The measurement is not dependent on the tank shape and on the presence of objects in close proximity to the reference tube.
Maximum electrode length 1 m.
- **DLM-35_-41 Coated rod electrode with reference tube (coaxial electrode)** for accurate level measurement of unpolluted electrically conductive liquids in plastic and glass tanks. The measurement is not dependent on the tank shape and on the presence of objects in close proximity to the reference tube. Maximum electrode length 1 m.
- **DLM-35_-50 Uncoated rope electrode with weight** for level measurement of bulk-solids (e.g. grains, sand, gravel, cement, etc.).
Maximum electrode length 6 m.
- **DLM-35_-52 Coated rope electrode with weight (FEP)**, for electrically conductive and non-conductive liquids. Maximum electrode length 10 m.

3. DIMENSIONAL DRAWINGS

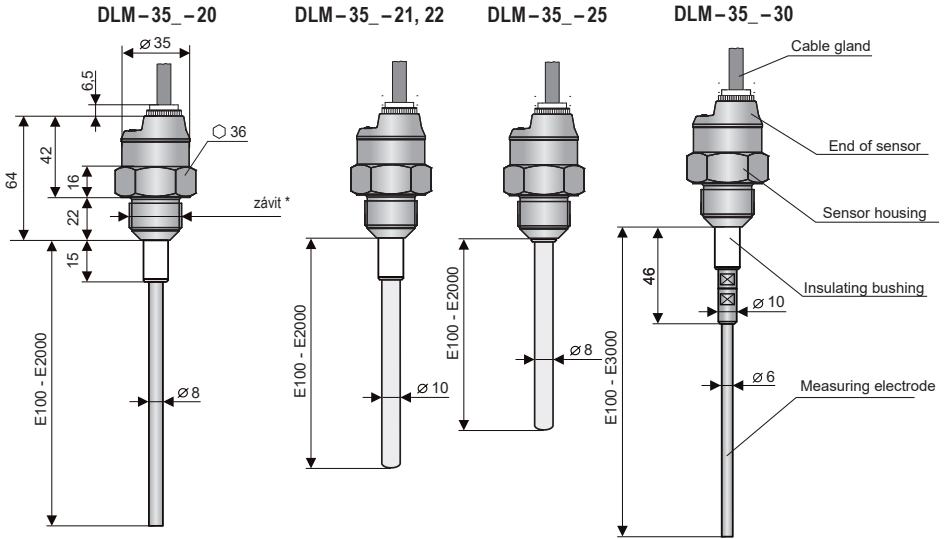

DLM-35_31

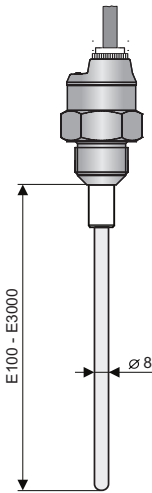

DLM-35_50

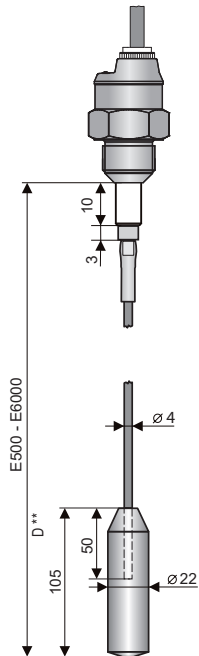

DLM-35_52

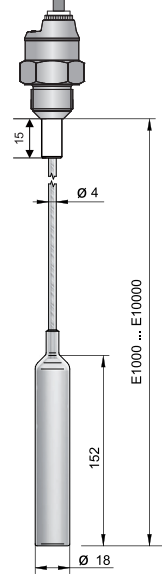

Process connection
Tri-clamp

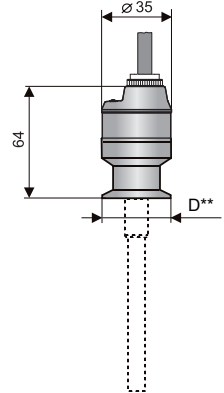

* Type of threads: G 1"; G 3/4"; M27x2;
M30x1,5; NPT 3/4

** D: Tri-Clamp CI34 (ø 34 mm)
Tri-Clamp CI50 (ø 50,5 mm)

All dimensions are in mm

DLM-35_40

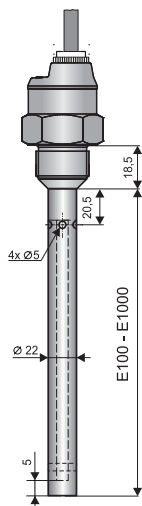

Variant "A" with short stainless steel gland

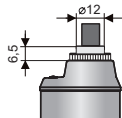

DLM-35_41

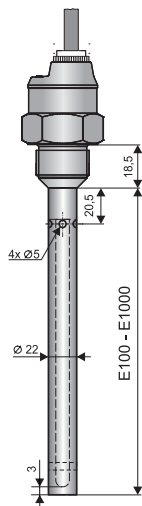

Variant "B" with plastic threaded cable gland

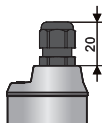

High temperatures variants

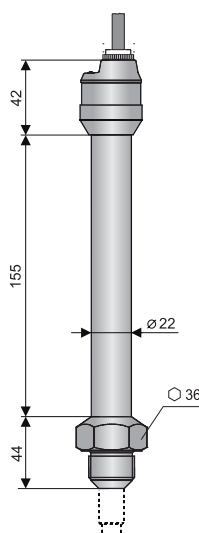

Variant "C" with connector M12

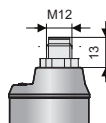

Variant "V" with plastic cable gland with spiral relief - for case of increased mechanical wear on the cable.

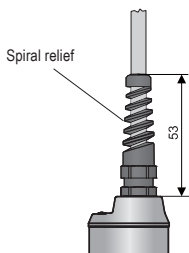

Variant "H" with cable gland for protected hoses - for using in an outdoor area or in area with increased moisture.

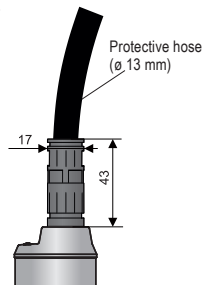

Variant "D" with dustproof cable outlet

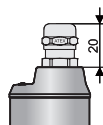

4. INSTALLATION AND PUTTING INTO OPERATION

Please follow next 3 steps:

- **INSTALLATION INSTRUCTIONS**
- **ELECTRICAL CONNECTION**
- **SETTINGS**

5. INSTALLATION INSTRUCTIONS

BASIC INFORMATION

- Level meters with an insulated electrode are equipped with a protective colored flexible rubber cap at the end of the electrode, which must be carefully removed by hand before mounting.
- Level meters mount in vertical position to upper lid of tank or reservoir by welding flange, fixing nut or Clamp flange.
- For mounting level meter to the metal tank or hopper, it is not necessary to ground the housing again.
- In case of installation in concrete sumps or silos, it is appropriate to install the level meter onto a metallic auxiliary construction (console, lid, etc.) and then connect with metal constantly submerged object, eventually with steel armouring.
- For level measurement of material in plastic and glass vessels by level meter without reference tube is necessary to connect grounding screw at housing with auxiliary electrode which is fixed in an appropriate manner to the outer casing of vessels (or at the inner wall). Material of auxiliary electrode must be selected with consideration for the working environment and properties of measured material.

VARIANTS WITH ROD ELECTRODE

For types : DLM-35_-20, 21, 22, 25, 30, 31

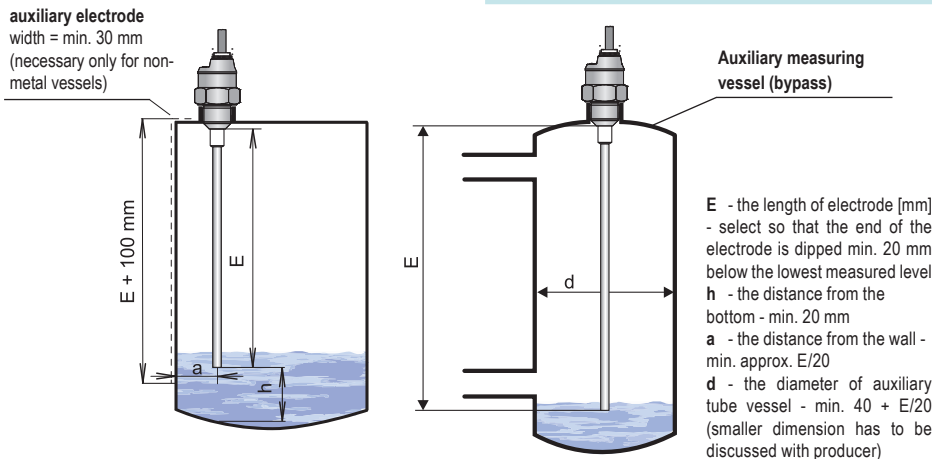
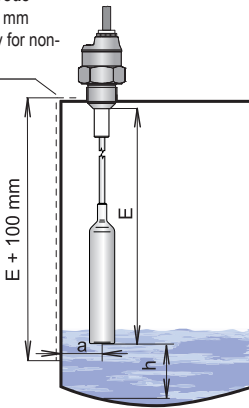

Fig. 1: Installation of level meters with rod electrode

VARIANT WITH ROPE INSULATED ELECTRODE

For types : DLM-35_-52

auxiliary electrode
width = min. 30 mm
(necessary only for non-metal vessels)



Auxiliary measuring vessel (bypass)

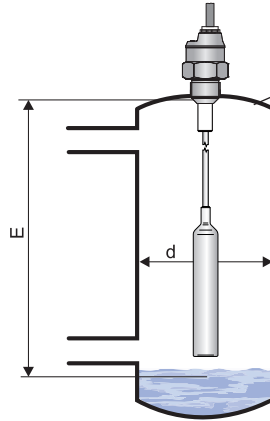

E - the length of electrode [mm]
- select so that the end of the electrode is dipped min. 20 mm below the lowest measured level
h - the distance from the bottom - min. 20 mm
a - the distance from the wall - min. approx. E/20
d - the diameter of auxiliary tube vessel - min. 40 + E/20 (smaller dimension has to be discussed with producer)

Fig. 2: Installation of level meters with rod electrode

VARIANTS WITH REFERENCE TUBE

For types : DLM-35_-40, 41

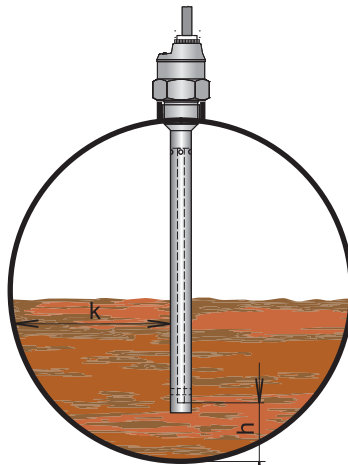

h - distance from bottom - min. 20 mm with regard to possibility of the presence of heavier fractions (water) in petroleum products
k - the distance from the wall - optional

Fig. 3: Installation of level meter with reference tube

DEEP METAL AND CONCRETE HOPPERS

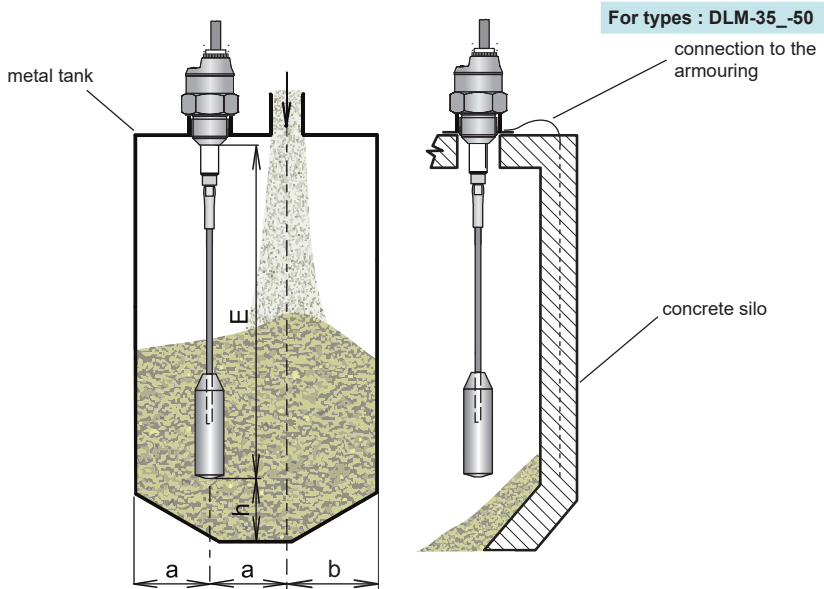

Fig. 4: Installation of level meter with rope electrode

- E** - electrode length [mm] - select so that the end of the electrode would be at least 20 mm under the lowest measured level
- h** - distance from bottom - min. 100 mm
- a** - distance from wall - min. E/20, otherwise select the largest (as far as possible from the wall), towards the middle between the wall and vertical drain

6. ELECTRICAL CONNECTION

The positive pole of the supply voltage (+U) is connected to the brown wire BN or pin connector no.1, the negative pole (0V) is connected to the blue wire BU or pin connector no. 3 and output voltage (Uout) to the black wire BK or pin connector no. 4.

Wiring diagrams are provided in the figures below 5 and 6.

Note: In case of strong ambient electromagnetic interference, paralleling of conductors with power distribution, or for the distribution to distance over 30 m, we recommend using shielded cable.

Level meters DLM-35 with type of cable outlet A, B, V or H are connected to assessing units permanently connected by PVC cable. Variant diagrams are provided on Fig. 8.

Level meters DLM-35 with connection method type C (see Fig. 8) are connected to assessing units by means of a connector socket with compression cable (length 2 or 5m), or by means of a connector socket without cable (see accessories), the connector is not part of the sensor. In this case the cable is connected to the inside pins of the socket according to figure 7. The recommended diameter of this cable is 4 to 6 mm (the recommended cross-sectional area is 0.25 to 0.5 mm²).

The length of the cable for the Xi, XiT, XiM, XiMT variations must be selected with respect to the maximum permitted parameters (usually inductance and capacity) of the outside intrinsically safe circuit of supply units IRU-420.

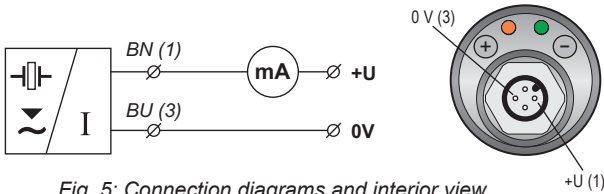

Fig. 5: Connection diagrams and interior view of connector of level meter DLM (variant - I)

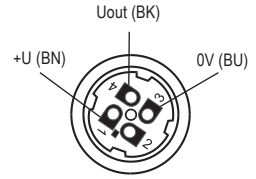

Fig. 7: Inside of the connector socket (variant "C")

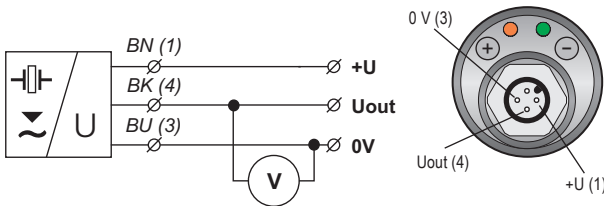

Fig. 6: Connection diagrams and interior view of connector of level meter DLM (variant - U)

Legend:

- (1...) – terminal numbers
- connector sockets
- BN –brown
- BU –blue
- BK –black



Electrical connection can only be made when de-energized!

The source of the power voltage must comprise of a stabilised safe low power source with galvanic separation. In the event that a switch-mode power supply is used, it is essential that its construction effectively suppresses common mode interference on the secondary side. In the event that the switch-mode power supply is equipped with a PE safety terminal, it must be unconditionally grounded! Spark-safe devices type DLM–35Xi (XiT, XiM, XiMT) must be powered from a spark-safe power source meeting the above-mentioned requirements.



Due to the possible occurrence of an electrostatic charge on the non-conductive parts of the sensor, it is necessary to ground all sensors intended for use in environments with an explosion hazard DLM–35Xi (XiT, XiM, XiMT). This can be performed by grounding el. conductive tanks or el. conductive tank lids, and in the case of el. non-conductive tanks using and grounding an auxiliary plate electrode PDE-27.

In the event that the level meter (sensor) is installed in an outdoor environment at a distance greater than 20 m from the outdoor switchboard, or from an enclosed building, it is necessary to supplement the electrical cable leading to the level meter (sensor) with suitable overvoltage protection.

In the event of strong ambient electromagnetic interference, paralleling of conductors with power distribution, or for distribution to distances over 30 m, we recommend using a shielded cable and grounding the shielding on the side of the power source.

7. CONTROL ELEMENTS

spot 

- input to setting mode
- direct setting to value 4 mA (0V)
- decrease in values along defined steps

spot 

- input to setting mode
- direct setting to value 20 mA (10V)
- increase in values along defined steps

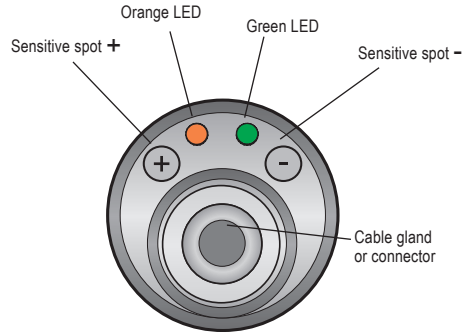



Fig. 8: Top view of level sensor

8. FUNCTION AND STATUS INDICATION

LED indicator	colour	function
"RUN"	green	<p>Measuring function indicator</p> <p>flashing – (repeats according to period of measuring approx. 0.5 s)</p> <ul style="list-style-type: none"> – correct function of measuring the level <p>dark</p> <ul style="list-style-type: none"> – incorrect installation or malfunction. LED is also not illuminated in limit setting mode. <p>alternating flashing green and orange LED – incorrectly set limits</p>
"STATE"	orange	<p>Settings indication</p> <p>slow flashing – indication of setting the lower limit</p> <p>rapid flashing – indication of setting the upper limit</p> <p>permanent shine – the level meter is prepared to confirm the limit setting by means of mag. pen</p> <p>3x short flashes – setting confirmation</p> <p>simultaneous shine of green and orange LED – during touching the mag. pen, when the limit setting is confirmed</p>

9. SETTINGS



Setting the device is done after its installation by touching the magnetic pen to sensitive spots  and . The setting process is indicated by the orange LED "STATE".

Connect the level meter to the power supply. Using a measuring device or associated device, check its output - current or voltage.



9.1. BASIC PROCEDURE FOR SETTING MINIMUM AND MAXIMUM LEVEL (DIRECT)

Basic method of setting the measuring range of the level meter. At this setting, the level in the tank must be brought to the minimum and then maximum level.

Setting lower limit 4 mA (0 V) - Direct

1. Empty the tank to the level of the minimum measured level. (To achieve the required linearity the end of the electrode has to be dipped, see Fig.1.)
2. Touch the magnetic pen for **approx. 5 seconds** on the sensitive spot  of the level meter. After 3 seconds, the LED indicator "STATE" starts to flash slowly. Keep the magnetic pen in touch with the sensitive spot and after 2 more seconds direct setting of the value 4 mA (0V) is performed.
3. Then put away the magnetic pen from sensitive spot and wait for permanent shine of the orange LED indicator "STATE".
4. After light up of the orange LED indicator "STATE", confirm the setting by short touch of the magnetic pen on the sensitive spot . After simultaneous light up of both LED indicators "STATE" and "RUN" it is possible to put away the magnetic pen. The LED indicator "STATE" will briefly flash 3x to confirm the setting of the limit.





Setting the upper limit 20 mA (10 V) - Direct

1. Fill the tank to the level of the maximum measured level.
2. Touch the magnetic pen for **approx. 5 seconds** on the sensitive spot  of the level meter. After 3 seconds, the LED indicator "STATE" starts to flash rapidly. Keep still the magnetic pen in touch with the sensitive spot and after 2 more seconds direct setting of the value 20 mA (10V) is performed.
3. Then put away the magnetic pen from sensitive spot and wait for permanent shine of the orange LED indicator "STATE".
4. After light up of the orange LED indicator "STATE", confirm the setting by short touch of the magnetic pen on the sensitive spot . After simultaneous light up of both LED indicators "STATE" and "RUN" it is possible to put away the magnetic pen. The LED indicator "STATE" will briefly flash 3x to confirm the setting of the limit.
5. If both LED indicators "STATE" and "RUN" begin flashing in alternating fashion, it means that the level meter cannot distinguish between the selected levels (limits are incorrectly set) - it is necessary to redo the settings.





9.2. PROCEDURE FOR SETTING AT ANY TWO LEVELS (INDIRECT)

This setting is used if it is not possible to bring the level to the minimum or maximum level. After setting of any two limit values, the electronics of the level meter automatically calculates the full measuring range 4 to 20 mA (or 0 to 10 V).

Setting the lower output value - Indirect

1. Bring the level in the tank to any known (determinable) level, best close to the minimum measured level.
2. Touch the magnetic pen for **approx. 3 seconds** on the sensitive spot  of the level meter. After 3 seconds, the LED indicator "STATE" starts to flash slowly and now put away the magnetic pen from the sensitive spot.
3. At the moment when the LED indicator "STATE" starts flashing slowly, by touching the magnetic pen on spots  and  it is possible to set the output value by stepping, which is calculated according to the formula:
 - for current output ... $I_{out} = 4 + (0.16 \times \text{height of level in } \%)$ [mA]
 - for voltage output ... $U_{out} = 0.1 \times \text{height of level in } \%$ [V](If the magnetic pen is kept on the sensitive spot, the setting step gradually increases.)
4. After reaching the lower output value, put away the magnetic pen from sensitive spots and wait for permanent shine of the orange LED indicator "STATE".
5. After light up of the orange LED indicator "STATE", confirm the setting by short touch of the magnetic pen on the sensitive spot . After simultaneous light up of both LED indicators "STATE" and "RUN" it is possible to put away the magnetic pen. The LED indicator "STATE" will briefly flash 3x to confirm the setting of the limit.

Setting the upper output value - Indirect

1. Bring the level in the tank to a known (determinable) level, best when close to the maximum measured level.
2. Touch the magnetic pen for **approx. 3 seconds** on the sensitive spot  of the level meter. After 3 seconds, the LED indicator "STATE" starts to flash rapidly, and now put away the magnetic pen from the sensitive spot.
3. At the moment when the LED indicator "STATE" starts flashing rapidly, by touching the magnetic pen on spots  and  it is possible to set the output value by stepping, which is calculated according to the formula:
 - for current output ... $I_{out} = 4 + (0.16 \times \text{level height in } \%)$ [mA]
 - for voltage output ... $U_{out} = 0.1 \times \text{level height in } \%$ [V](If the magnetic pen is kept on the sensitive spot, the setting step gradually increases.)
4. After reaching the upper output value, put away the magnetic pen from sensitive spots and wait for permanent shine of the orange LED indicator "STATE".
5. After light up of the orange LED indicator "STATE", confirm the setting by short touch of the magnetic pen on the sensitive spot . After simultaneous light up of both LED indicators "STATE" and "RUN" it is possible to put away the magnetic pen. The LED indicator "STATE" will briefly flash 3x to confirm the setting of the limit.
6. If both LED indicators "STATE" and "RUN" begin flashing in alternating fashion, it means that the level meter cannot distinguish between the selected levels - it is necessary either to decrease the level for setting the lower output value or increase the level for setting the upper output value.

10. ORDER CODE

ORDER CODE

DLM-35

PERFORMANCE

N	non-explosive areas
NT	high temperature performance
Xi	for explosive environments ☉
XiM	for mining environments ☉
XiT	high-temperature conf. for explosive environments ☉, only with current output I
XiMT	high-temperature conf. for mining environments ☉, only with current output I

TYPE OF ELECTRODE

20	rod, uncoated, length 0.1 ... 2 m
21	rod, coated (FEP), length 0.1 ... 2 m
22	rod, coated (PFA), length 0.1 ... 2 m
25	like 21, but higher pressure and mechanical resistance at high temperatures NT variant is only available for Tri-clamp
30	rod, uncoated, length 0.1 ... 3 m
31	rod, coated (FEP), length 0.1 ... 3 m
40	rod, uncoated with ref. tube, length 0.1 ... 1 m, not possible for process connection CL34 and CI50
41	rod, coated (FEP) with ref. tube, length 0.1 ... 1 m not possible for process connection CL34 and CI50
50	rope with weight, uncoated, length 1 ... 6 m, not possible for process connection CL34 and CI50
52	coated rope electrode with coated weight (FEP), length 1 -- 10 m

PROCESS CONNECTION

G1	pipe thread G 1"
G3/4	pipe thread G 3/4"
M27	metric thread M 27x2
M30	metric thread M 30x1.5
NPT	pressure thread NPT 3/4
CI34	Tri-clamp (ø 34 mm)
CI50	Tri-clamp (ø 50,5 mm)

OUTPUT TYPE

I	current (4 ... 20 mA)
U	voltage (0 ... 10 V)

ELECTRICAL CONNECTION

A	short stainless steel gland
B	plastic threaded cable gland
C	connector (socket not included - see accessories)
V	plastic cable gland with spiral
H	plastic cable gland for protective hose

LENGTH OF ELECTRODE

E	electrode length in mm
----------	------------------------

CABLE

K	cable length in
----------	-----------------

DLM-35 N - 20 - G1 - I - A E50 K5 EXAMPLE OF CODING

11. CORRECT SPECIFICATION EXAMPLES

DLM-35N-20-M27-I-B E200 K 5

(N) non-explosive areas; (20) uncoated cylindrical electrode; (M27) process connection by thread M27; (I) output current; (B) plastic threaded cable gland; (E200) electrode length 200 mm.

DLM-35N-21-G3/4-U-C E580

(N) non-explosive areas; (21) coated bar electrode (FEP); (G3/4) process connection by thread G3/4"; (U) output voltage; (C) connector; (E580) electrode length 580 mm.

DLM-35N-40-M30-I-H E900

(N) non-explosive areas; (40) uncoated rod electrode with reference tube; (M30) process connection by thread M30; (I) output current; (H) cable gland for protective hose; (E900) electrode length 900 mm.

DLM-35XiT-20-M27-I-B E200 K5

(XiT) high-temperature conf. for explosive environments; (20) uncoated cylindrical electrode; (M27) process connection by thread M27; (I) output current; (B) plastic threaded cable gland; (E200) electrode length 200 mm.

DLM-35N-22-CI50-U-A E200 K5

(N) non-explosive areas; (22) coated bar electrode (PFA); (CI50) process connection Tri-clamp (ø 50,5 mm); (U) output voltage; (A) short stainless steel gland; (E200) electrode length 200 mm.

12. ACCESSORIES

standard – included in the level sensor price

- 1 pcs. magnetic pen MP-8
- 1 pcs. seal (asbestos free) *

* Pressure resistance - see the table in the accessories datasheet in the "seals and gaskets".

optional – for a surcharge

(see catalogue sheet of accessories)

- cable (over the standard length 2m)
- connector socket (type ELWIKa or ELKA)
- normal steel welding flange or stainless steel welding flange
- protective hose (for type of cable outlet H)
- stainless steel fixing nut
- various types of seals (PTFE, Al, etc.)

13. SAFETY, PROTECTIONS, COMPATIBILITY AND EXPLOSION PROOF

The level sensor is equipped with protection against electric shock on the electrode, reverse polarity, output current overload, short circuit and against current overload on output.

Protection against dangerous contact is provided by low safety voltage according to EN 33 2000- 4- 41. Electromagnetic compatibility is provided by conformity with standards EN 55011, EN 61326-1, EN 61000-4-2 to -6, -8.

Explosion proof DLM-35Xi (XiT, XiM, XiMT) is provided by conformity with standards EN 60079-0, EN 60079-11, EN 60079-26.

Explosion proof DLM-35Xi (XiT, XiM, XiMT) is verified FTZÚ Ostrava – Radvanice: FTZÚ 16 ATEX 0138X.

A declaration of conformity was issued for this device in the wording of Act No. 90/2016 Coll., as amended. Supplied electrical equipment matches the requirements of valid European directives for safety and electromagnetic compatibility.

Special conditions for safe use of variant DLM-35Xi (XiT, XiM, XiMT)

Specific Conditions of Use:

Connected intrinsically safe apparatus must be galvanically separated or in the case of using the apparatus without galvanic separation (Zener barrier), it is necessary to carry out the equalization of potentials between transducer and the place of barriers.

The version DLM-35Xi can be placed into Zone 0 or Zone 20. For the implementation DLM-35XiT the only sensing electrode can be placed into Zone 0 or Zone 20, the head with electronics can be placed only into Zone 1 or Zone 21. The sensing electrodes maximal temperature is given by temperature of measured process media.

Temperature class and maximal surface temperature depends on process media temperature.

Version Xi:

Temperature class for EPL Ga:

T2 ... for maximal process media temperature $T_m=270^{\circ}\text{C}$.

T3 ... for maximal process media temperature $T_m=180^{\circ}\text{C}$.

T4 ... for maximal process media temperature $T_m=115^{\circ}\text{C}$.

Maximal surface temperature for EPL Da:

Maximal process media temperature range is from -40°C to $+300^{\circ}\text{C}$.

Maximal surface temperature shall be calculated as $T_{200}=T_m+45^{\circ}\text{C}$.

Version XiT:

Temperature class for EPL Ga/Gb:

T2 ... for maximal process media temperature $T_m=270^{\circ}\text{C}$.

T3 ... for maximal process media temperature $T_m=180^{\circ}\text{C}$.

T4 ... for maximal process media temperature $T_m=115^{\circ}\text{C}$.

Maximal surface temperature for EPL Da/Db:

Process media temperature range id from -40°C to 300°C .

Maximal surface temperature of EPL Da part of product shall be calculated as $T_{200}=T_m+45^{\circ}\text{C}$.

Maximal surface temperature of EPL Db part of product shall be calculated as $T=T_m+15^{\circ}\text{C}$.

Version XiM, XiMT:

Maximal temperature of process media is 135°C .

Equipment for application in explosive dust atmosphere must be installed in such a manner that the risk of propagating brush discharges is avoided. This restriction applies only to the part of the equipment where the label, cable gland or connector is located.

14. USE, MANIPULATION AND MAINTENANCE

The level meter does not require any personnel for its operation. Maintenance of this equipment consists in verification of integrity of the level meter and of the supply cable.



It is forbidden to perform any modifications or interventions into the DLM-35 level meter without manufacturer's approval. Any repairs must only be carried out by the producer or authorized service organisations.

Installation, commissioning, operation and maintenance of the DLM-35 level meter has to be carried out in accordance with this instruction manual; the provisions of regulations in force regarding the installation of electrical equipment have to be adhered to.

15. GENERAL, CONDITIONS AND WARRANTY

Dinel, s.r.o. guarantees for the period of three (3) years that the product has the characteristics as mentioned in the technical specification.

Dinel, s.r.o. is liable for defects ascertained within the warranty period and were claimed in writing.

This guarantee does not cover the damages resulting from misuse, improper installation or incorrect maintenance.

This guarantee ceases when the user or the other person makes any changes on the product or the product is mechanically or chemically damaged, or the serial number is not readable.

The warranty certificate must be presented to exercise a claim.

In the case of a rightful complaint, we will replace the product or its defective part. In both cases, the warranty period is extended by the period of repair.

16. MARKING OF LABELS

Labels for device of the type **DLM-35N(T)-___-___-I-_-_-**:

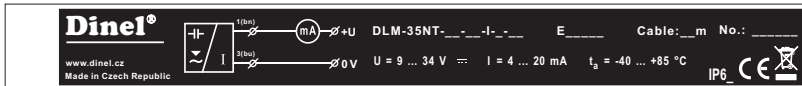
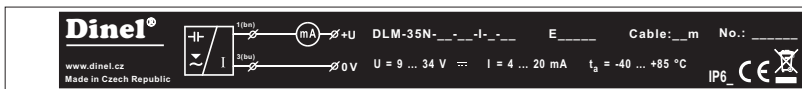

Symbol of producer: logo Dinel®

Internet address: www.dinel.cz

Country of origin: Made in Czech Republic

Connection scheme and labelling of wires: +U, 0 V

Type of level meter: DLM-35N(T)-___-___-I-_-_- E_____

Cable length: Cable: ___ m

Serial number: Ser. No.: _____ – (from the left: production year, serial production number)

Output current range: U = 9 ... 34 V =

Supply voltage range: $I = 4 \dots 20 \text{ mA}$
 Ambient temperature range: $t_a = -40 \dots +85 \text{ }^\circ\text{C}$
 Protection class: IP6_ (see. Protection class according to electrical connection)
 Compliance mark: **CE**
 Electro-waste take-back system mark:

Labels for device of the type **DLM-35N(T)-_ _ _ U- _ _ _**:

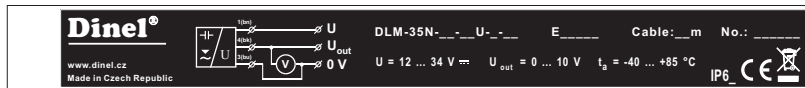

Symbol of producer: logo Dinel®
 Internet address: www.dinel.cz
 Country of origin: Made in Czech Republic
 Connection scheme and labelling of wires: +U, Uout, 0 V
 Type of level meter: DLM-35N(T)-_ _ _ U- _ _ _ E _ _ _ _ _
 Cable length: Cable: _ _ m
 Serial number: Ser. No.: _ _ _ _ _ _ _ _ (from the left: production year, serial production number)
 Supply voltage range: $U = 12 \dots 34 \text{ V}$
 Output voltage range: $U_{out} = 0 \dots 10 \text{ V}$
 Ambient temperature range: $t_a = -40 \dots +85 \text{ }^\circ\text{C}$
 Protection class: IP6_ (see. Protection class according to electrical connection)
 Compliance mark: **CE**
 Electro-waste take-back system mark:

Labels for device of the type **DLM-Xi(XiT)**
for electrodes 20, 30, 40, 50

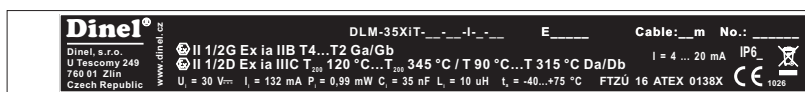
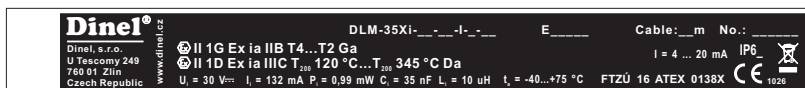

Labels for device of the type **DLM-Xi(XiT)**
for electrodes 21, 22, 25, 31, 41, 52

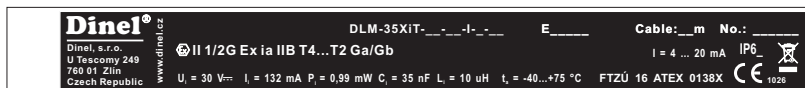
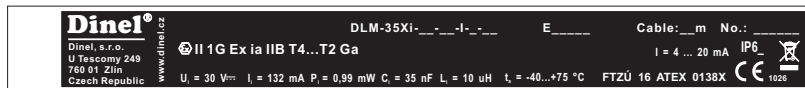

Symbol of producer: logo Dinel®

Contact: Dinel, s.r.o., U Tescomy 249, 760 01 Zlín, Czech Republic, www.dinel.cz

Connection scheme and labelling of wires:+U, 0V

Type of level meter: DLM-35Xi(XiT)-__-__-I-__-__ E_____

Cable length: Cable: __ m

Serial number: Ser. No.: _____ – (from the left: production year, serial production number)

Mark of non-explosive device:

variant (Xi):  II 1G Ex ia IIB T4...T2 Ga;  II 1D Ex ia IIIC T₂₀₀ 120 °C ...T₂₀₀ 345 °C Da

variant (XiT):  II 1/2G Ex ia IIB T4...T2 Ga/Gb;

 II 1/2D Ex ia IIIC T₂₀₀ 120 °C ... T₂₀₀ 345 °C / T 90 °C ... T 315 °C Da/Db

Supply voltage range: I=4 ...20 mA

Limit parameters: U_i=30 V=, I_i=132 mA; P_i=0,99 W; C_i=35 nF; L_i=10 μH

Ambient temperature range: t_a= -40 ... +75 °C

Number of certificate of intrinsic safety: FTZÚ 16 ATEX 0138X

Protection class: IP6_; Compliance mark: 

Number of authorized person supervising over the quality system: 1026

Electro-waste take-back system mark: 

Labels for device of the type **DLM-XiM(XiMT)**:

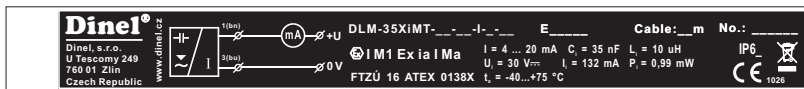
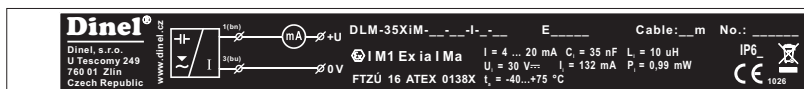

Symbol of producer: logo Dinel®

Contact: Dinel, s.r.o., U Tescomy 249, 760 01 Zlín, Czech Republic, www.dinel.cz

Connection scheme and labelling of wires:+U, 0V

Type of level meter: DLM-35XiM(XiMT)-__-__-I-__-__ E_____

Cable length: Cable: __ m

Serial number: Ser. No.: _____ – (from the left: production year, serial production number)

Mark of non-explosive device:  I M1 Ex ia I Ma

Supply voltage range: I=4 ...20 mA

Limit parameters: U_i=30 V=, I_i=132 mA; P_i=0,99 W; C_i=35 nF; L_i=10 μH

Ambient temperature range: t_a= -40 ... +75 °C

Number of certificate of intrinsic safety: FTZÚ 16 ATEX 0138X

Protection class: IP6_; Compliance mark: 

Number of authorized person supervising over the quality system: 1026

Electro-waste take-back system mark: 



Size of labels 112 x 12 mm, the size shown does not correspond to reality.

17. TECHNICAL SPECIFICATIONS

BASIC TECHNICAL DATA

Supply voltage	DLM-35N(T)-__-__-I DLM-35N(T)-__-__-U	9 ... 34 V DC 12 ... 34 V DC
Current output Voltage output		4 ... 20 mA (2-wire) 0 ... 10 V (3-wire)
Power consumption	DLM-35__-__-__-I DLM-35__-__-__-U	3.75 ... 20.5 mA 5 mA (voltage output open circuit)
Non-linearity		max. 1 %
Temperature error		max. 0.05% / K
Voltage error for current and voltage output		max. 0.3 μ A/V and 0.1 mV/V
Leakage resistance (electrode - housing) / dielectric strength		1 M Ω / 200 V DC
Coupling capacity (housing - power) / dielectric strength		50 nF / 350 V AC
Coupling capacity (electrode - power) / dielectric strength		47 nF / 350 V AC
Ambient temperature range:		- 40 ... + 85 °C
Protection	type DLM-35__-__-C-__-__ type DLM-35__-__-A(B,V,H)-__-__	IP67 IP68
Maximum load resistance for current output (at U = 24 V)		R _{max} = 700 Ω
Weight (excluding electrode and cable)	performance N performance NT	approx. 0.3 kg approx. 0.6 kg
Cable (version with cable glands)		PVC 3 x 0.5 mm ² (version N) or 2 x 0.75 mm ² (version Xi)

ELECTRICAL PARAMETERS (variant Xi, XiT, XiM, XiMT)

Power supply voltage	9 ... 30 V DC
Limit values	U _i = 30 VDC; I _i = 132 mA; P _i = 0,99 W; C _i = 35 nF; L _i = 10 μ H
Reference value LC for the parameters of the used cable	typic C < 150 pF/m typic L < 0,8 μ H /m

PROCESS CONNECTION

type	size	marking
Pipe thread	G 1"	G 1
	G 3/4"	G3/4
Metric thread	M27x2	M27
	M30x1,5	M30
Taper pipe thread	NPT 3/4	NPT
Jointless connection (Tri-Clamp)	\varnothing 34 mm	CI34
	\varnothing 50,5 mm	CI50

USE MATERIALS

sensor part	variants	standard material *
Wetted parts:		
Housing	all types expect Tri-Clamp Tri-Clamp	stainless steel W.Nr. 1.4301 (AISI 304) stainless steel W.Nr. 1.4404 (AISI 316L)
Rod electrode	all types expect DLM-35_-50, 52	stainless steel W.Nr. 1.4404 (AISI 316L)
Rope electrode	DLM-35_-50	stainless steel W.Nr. 1.4401 (AISI 316)
Reference tube	DLM-35_-40, 41	stainless steel W.Nr. 1.4301 (AISI 304)
Insulating bushing	DLM-35_-20, 21, 22, 30, 31, 40, 41, 52	PTFE
	DLM-35_-25, 50	PPS + GF40
Electrode coating	DLM-35_-21, 31, 41, 25	FEP
	DLM-35_-22	PFA
Weight	DLM-35_-50	stainless steel W.Nr. 1.4301 (AISI 304)
No wetted parts:		
Rod electrode	DLM-35_-21, 22, 25, 31, 41	stainless steel (W.Nr. 1.4404 (AISI 316L))
Rope electrode with weight	DLM-35_-52	stainless steel (W.Nr. 1.4301 (AISI 304L))
Cable gland	DLM-35_-__-A	stainless steel W.Nr. 1.4571 (AISI 316 Ti)/NBR
	DLM-35_-__-B	plastic PA / NBR
	DLM-35_-__-D	nickel-plated brass / PA / rubber CR / NBR
	DLM-35_-__-V	plastic PA / NBR
	DLM-35_-__-H	plastic PA / NBR
Connector M12	DLM-35_-__-C	nickel-plated brass / PA
End of sensor with thread / Tri-Clamp	all types	stainless steel W.Nr. 1.4301 (AISI 304)

** It is always necessary to verify the chemical compatibility of the material with the measured medium. You can also choose another type of material after agreement.*

WORKING AREAS AND AREA CLASSIFICATION (EN 60079-0, EN 60079-10-1(2))

DLM-35N	Basic performance for non-explosive atmospheres.
DLM-35NT	High-temperature basic performance for non-explosive atmospheres.
DLM-35Xi (20, 30, 40, 50)	Intrinsically safe explosion-proof performance for use in hazardous areas (explosive gas atmospheres or explosive atmospheres with dust) Ⓢ II 1G Ex ia IIB T4...T2 Ga; Ⓢ II 1D Ex ia IIIC T ₂₀₀ 120 °C...T ₂₀₀ 345 °C Da with intrinsically safe supply units, whole sensor zone 0 and 20.
DLM-35Xi (21, 22, 25, 31, 41, 52)	Intrinsically safe explosion-proof performance for use in hazardous areas (explosive gas atmospheres) Ⓢ II 1G Ex ia IIB T4...T2 Ga; with intrinsically safe supply units, whole sensor zone 0.
DLM-35XiT (20, 30, 40, 50)	Intrinsically safe high-temperature explosion-proof performance for use in hazardous areas (explosive gas atmospheres or explosive atmospheres with dust) Ⓢ II 1/2G Ex ia IIB T4...T2 Ga/Gb; Ⓢ II 1/2D Ex ia IIIC T ₂₀₀ 120 °C ... T ₂₀₀ 345 °C / T 90 °C ... T 315 °C Da/Db with intrinsically safe supply units, electrode part zone 0 and 20, head zone 1 and 21.
DLM-35XiT (21, 22, 25, 31, 41, 52)	Intrinsically safe high-temperature explosion-proof performance for use in hazardous areas (explosive gas atmospheres) Ⓢ II 1/2G Ex ia IIB T4...T2 Ga/Gb; with intrinsically safe supply units, electrode part zone 0, head zone 1.
DLM-35XiM	Intrinsically safe explosion-proof performance for use in mines with the occurrence of methane or coal dust Ⓢ I M1 Ex ia I Ma with intrinsically safe supply units.
DLM-35XiMT	Intrinsically safe high-temperature explosion-proof performance for use in mines with the occurrence of methane or coal dust Ⓢ I M1 Ex ia I Ma with intrinsically safe supply units.

A device or part of a device intended for zone 0 can also be used in zone 1 or 2.

A device or part of a device intended for zone 1 may also be used in zone 2.

A device or part thereof intended for zone 20 may also be used in zone 21 or 22.

A device or part of a device intended for zone 21 may also be used in zone 22.

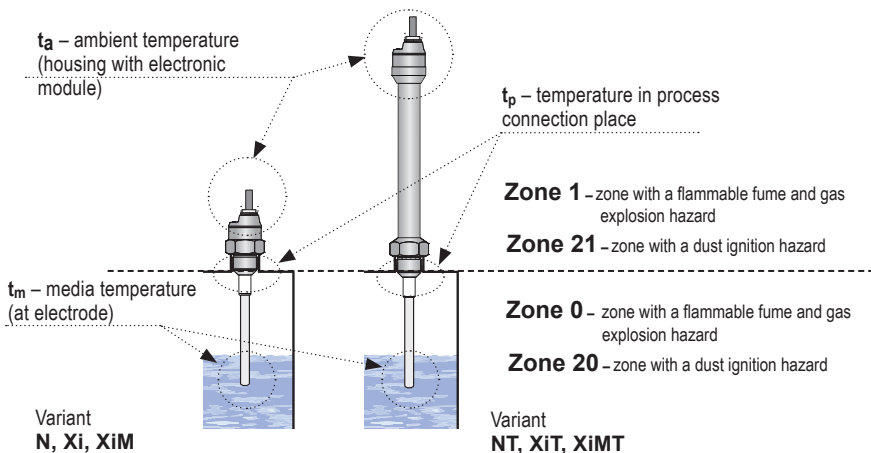

Fig. 9: Illustration of areas for temperature measurement and explosive zones

MAXIMUM MEDIUM TEMPERATURE FOR Xi(XiT) CATEGORY 1G, 1/2G	
temperature class	temperature tm
T4	+115 °C
T3	+180 °C
T2	+270 °C

MAXIMUM MEDIUM TEMPERATURE FOR XiM(XiMT) CATEGORY M1	
maximum medium temperature	+ 135 °C

MAXIMUM SURFACE TEMPERATURE OF Xi(XiT) DEVICES OF CATEGORY 1D, 1/2D	
in place of the head with electronics	$T_{200} = T_m + 45 \text{ °C}$ (verze Xi) $T = T_m + 15 \text{ °C}$ (verze XiT)
at the process connection point	$T_{200} = T_m + 45 \text{ °C}$ (verze Xi) $T = T_m + 15 \text{ °C}$ (verze XiT)
on the electrode	$T_{200} = T_m + 45 \text{ °C}$

TEMPERATURE RESISTANCE (versions N, NT, Xi, XiM, XiT, XiMT)			
design variant	temperature tm	temperature tp	temperature ta
DLM-35N-20, 30	-40 °C ... +300 °C	-40 °C ... +85 °C	-40 °C ... +85 °C
DLM-35N-21, 22, 25, 31, 40, 41, 52	-40 °C ... +200 °C	-40 °C ... +85 °C	-40 °C ... +85 °C
DLM-35N-50	-40 °C ... +250 °C	-40 °C ... +85 °C	-40 °C ... +85 °C
DLM-35NT-20, 30,	-40 °C ... +300 °C	-40 °C ... +200 °C	-40 °C ... +85 °C
DLM-35NT-21, 22, 25, 31, 40, 41, 52	-40 °C ... +200 °C	-40 °C ... +200 °C	-40 °C ... +85 °C
DLM-35NT-50	-40 °C ... +250 °C	-40 °C ... +200 °C	-40 °C ... +85 °C
DLM-35Xi, XiM-20, 30	-40 °C ... +300 °C	-40 °C ... +75 °C	-40 °C ... +75 °C
DLM-35Xi, XiM-21, 22, 25, 31, 40, 41, 52	-40 °C ... +200 °C	-40 °C ... +75 °C	-40 °C ... +75 °C
DLM-35Xi, XiM-50	-40 °C ... +250 °C	-40 °C ... +75 °C	-40 °C ... +75 °C
DLM-35XiT, XiMT-20, 30	-40 °C ... +300 °C	-40 °C ... +200 °C	-40 °C ... +75 °C
DLM-35XiT, XiMT-21, 22, 25, 31, 40, 41, 52	-40 °C ... +200 °C	-40 °C ... +200 °C	-40 °C ... +75 °C
DLM-35XiT, XiMT-50	-40 °C ... +250 °C	-40 °C ... +200 °C	-40 °C ... +75 °C
DLM-35XiM, XiMT - mining environment Ma	max. 150 °C on any surface where coal dust can form layers		

Note:

The level gauge must be installed in a vertical position and must not exceed any of the specified temperature ranges (tp, tm or ta). These temperatures are illustrated in Fig. 9.

FACTORY DEFAULT

4 mA (0V)	electrode system capacity in open space
20 mA (10V)	capacity 1nF ($\pm 20\%$)



This setting can not be used directly for level measurement, but it is always necessary to make setting according to chapter 9.

In special cases (e.g.: by using reference electrode) sensor settings can be agreed with the manufacturer.

PRESSURE RESISTIVITY (variant N, NT, Xi, XiM, XiT, XiMT)

variant	max. operating pressure for temperature t_p				
	Up to 30°C	Up to 85°C	Up to 120°C	Up to 150°C	Up to 200°C
DLM-35N-20, 30	5 MPa (50 bar)	2,5 MPa (25 bar)	–	–	–
DLM-35N-21, 22, 31, 40, 41	5 MPa (50 bar)	2,0 MPa (20 bar)	–	–	–
DLM-35N-25	2,0 MPa (20 bar)	2,0 MPa (20 bar)	–	–	–
DLM-35N-50	0,1 MPa (1 bar)	0,1 MPa (1 bar)	–	–	–
DLM-35N-52	1 MPa (10 bar)	0,5 MPa (5 bar)	–	–	–
DLM-35NT-20, 30,	5 MPa (50 bar)	2,5 MPa (25 bar)	1,5 MPa (15 bar)	1 MPa (10 bar)	0,5 MPa (5 bar)
DLM-35NT-21, 22, 31, 40, 41	5 MPa (50 bar)	2,0 MPa (20 bar)	1,5 MPa (15 bar)	1 MPa (10 bar)	0,1 MPa (1 bar)
DLM-35NT-25	2,0 MPa (20 bar)	2,0 MPa (20 bar)	2,0 MPa (20 bar)	2,0 MPa (20 bar)	2,0 MPa (20 bar)
DLM-35NT-50	0,1 MPa (1 bar)	0,1 MPa (1 bar)	0,1 MPa (1 bar)	0,1 MPa (1 bar)	0,1 MPa (1 bar)
DLM-35NT-52	1 MPa (10 bar)	0,5 MPa (5 bar)	0,2 MPa (2 bar)	0,2 MPa (2 bar)	–
DLM-35Xi, XiM-20, 30	5 MPa (50 bar)	2,5 MPa (25 bar)	–	–	–
DLM-35Xi, XiM-21, 22, 31, 40, 41	5 MPa (50 bar)	2,0 MPa (20 bar)	–	–	–
DLM-35Xi, XiM-25	2,0 MPa (20 bar)	2,0 MPa (20 bar)	–	–	–
DLM-35Xi, XiM-50	0,1 MPa (1 bar)	0,1 MPa (1 bar)	–	–	–
DLM-35Xi, XiM-52	1 MPa (10 bar)	0,5 MPa (5 bar)	–	–	–
DLM-35XiT, XiMT-20, 30	5 MPa (50 bar)	2,5 MPa (25 bar)	1,5 MPa (15 bar)	1 MPa (10 bar)	0,5 MPa (5 bar)
DLM-35XiT, XiMT-21, 22, 31, 40, 41	5 MPa (50 bar)	2,0 MPa (20 bar)	1,5 MPa (15 bar)	1 MPa (10 bar)	0,1 MPa (1 bar)
DLM-35XiT, XiMT-25	2,0 MPa (20 bar)	2,0 MPa (20 bar)	2,0 MPa (20 bar)	2,0 MPa (20 bar)	2,0 MPa (20 bar)
DLM-35XiT, XiMT-50	0,1 MPa (1 bar)	0,1 MPa (1 bar)	0,1 MPa (1 bar)	0,1 MPa (1 bar)	0,1 MPa (1 bar)
DLM-35XiT, XiMT-52	1 MPa (10 bar)	0,5 MPa (5 bar)	0,2 MPa (2 bar)	0,2 MPa (2 bar)	–

18. PACKINGS, SHIPPING AND STORAGE

The device DLM-35 is packaged in a polyethylene bag, and the entire consignment is placed into a cardboard box. A suitable filler material is used in the cardboard box to prevent mechanical damage during transport. Remove the device from the packaging only just before using, thereby protecting it from potential damage.

A forwarding company will be used to ship goods to the customer. Upon prior agreement, ordered goods can be picked up in person at company headquarters. When receiving, please check to see that the consignment is complete and matches the order, or to see if any damage has occurred to the packaging and device during transport. Do not use a device clearly damaged during transport, but rather contact the manufacturer in order to resolve the situation.

If the device is to be further shipped, it must be wrapped in its original packaging and protected against impact and weather conditions.

Store the device in its original packaging in dry areas covered from weather conditions, with humidity of up to 85 % without effects of chemically active substances. The storage temperature range is -10 °C to +50 °C.



All level meters except the type variant DLM-35_-50 are given protective covers at ends of electrodes (longer than 100 mm) and of reference tubes in order to prevent damage to electrode and tubes, tearing of the package or injury of persons handling them. Remove the cover prior to putting into operation.

Dinel[®]

industrial electronics

Dinel, s.r.o.
U Tescomy 249
760 01 Zlín
Czech Republic

Phone: +420 577 002 002
E-mail: sale@dinel.cz

www.dinel.cz

Find the updated version at www.dinel.cz

version: 09/2024

