



## ULTRASONIC LEVEL METERS ULM – 70

---



Firmware: v.2.0

# TABLE OF CONTENTS

---

<b>1. Basic description</b> .....	3
<b>2. Range of applications</b> .....	3
<b>3. Variants of sensors</b> .....	4
<b>4. Dimensional drawings</b> .....	4
<b>5. Installation and putting into operation</b> .....	5
<b>6. Mechanical mounting</b> .....	5
<b>7. Electrical connection</b> .....	9
<b>8. Examples of ULM-70 connection</b> .....	11
8.1. Wiring diagram of the level meter with current output and PDU unit .....	11
8.2. Wiring diagram of the level meter with current output and PDU unit in versions for explosive areas .....	12
8.3. Wiring diagram of the level meter with current output and MGU unit .....	14
8.4. Wiring diagram of the level meter with Modbus / RS485 and MGU unit .....	14
8.5. Wiring diagram of the level meter with Modbus / RS485 and PDU unit .....	14
<b>9. Setting elements</b> .....	15
<b>10. Operation and Settings</b> .....	16
10.1. Basic configuration .....	16
10.2. Service settings .....	20
10.3. Additional functions .....	22
<b>11. Protocol HART®</b> .....	25
<b>12. Protocol Modbus</b> .....	26
<b>13. Function and status indication</b> .....	26
<b>14. Order code</b> .....	27
<b>15. Accessories</b> .....	28
<b>16. Safety, protection, compatibility and explosion proof</b> .....	28
<b>17. Use, manipulation and maintenance</b> .....	29
<b>18. Marking of labels</b> .....	29
<b>19. Technical specifications</b> .....	31
<b>20. Packing, shipping and storage</b> .....	33
<b>21. Menu structure</b> .....	34

## USED SYMBOLS

---

To ensure maximum safety of control processes, we have defined the following safety instructions and information. Each instruction is labelled with the appropriate pictogram.



### **Alert, warning, danger**

This symbol informs you about particularly important instructions for installation and operation of equipment or dangerous situations that may occur during the installation and operation. Not observing these instructions may cause disturbance, damage or destruction of equipment or may cause injury.



### **Information**

This symbol indicates particularly important characteristics of the device.



### **Note**

This symbol indicates helpful additional information.

## SAFETY

---



All operations described in this instruction manual have to be carried out only by trained personnel or an accredited person. Warranty and post warranty service must be exclusively carried out by the manufacturer.

Improper use, installation or set-up of the level meter can result in crashes in the application (overflowing of the tank or damage of system components).

The manufacturer is not responsible for improper use, losses of work caused by either direct or indirect damage, and for expenses incurred during installation or use of the level meter.

## 1. BASIC DESCRIPTION

---

Ultrasonic level meter ULM® is a compact measuring device consisting of two parts - main level meter (the body with measuring electronics) and display module. Using the electroacoustic converter, the level meters transmit the sequence of ultrasonic pulses that spread towards the surface level. The converter recuperates reflected acoustic waves that are subsequently processed in the electronic module. The intelligent evaluation block filters out interfering signals, compares the cleaned received signal with the false reflection map (e.g. from mixers, ladders, reinforcement etc.) and selects a suitable reflection (echo). Based on the period during which the individual pulses spread towards the surface level and back and based on the measured temperature in the tank, the instant distance to the surface level is calculated. According to the level height, the level meter output is set and the measured value is displayed on the display.

## 2. RANGE OF APPLICATIONS

---

Thanks to their non-contact sensing principle, level meter are suitable for continuous level measurement of liquids, wastewater, sludge, bulk materials, suspensions, adhesives, resins in various open and closed containers, sumps, channels or troughs. The applicability for measuring the level of bulk materials is limited and the measuring range is shortened.

### 3. VARIANTS OF SENSORS

- ULM-70\_02**    **Measuring range from 0.15m to 2m**, plastic PVDF transmitter, mechanical connection with thread G 1".
- ULM-70\_06**    **Measuring range from 0.25m to 6m**, plastic PVDF transmitter, mechanical connection with thread G 1 ½".
- ULM-70\_10**    **Measuring range from 0.4m to 10m**, plastic PVDF transmitter, mechanical connection with thread G 2 ¼".
- ULM-70\_20**    **Measuring range from 0.5m to 20m**, plastic PVDF transmitter, mechanical connection with aluminium alloy flange.

### 4. DIMENSIONAL DRAWINGS

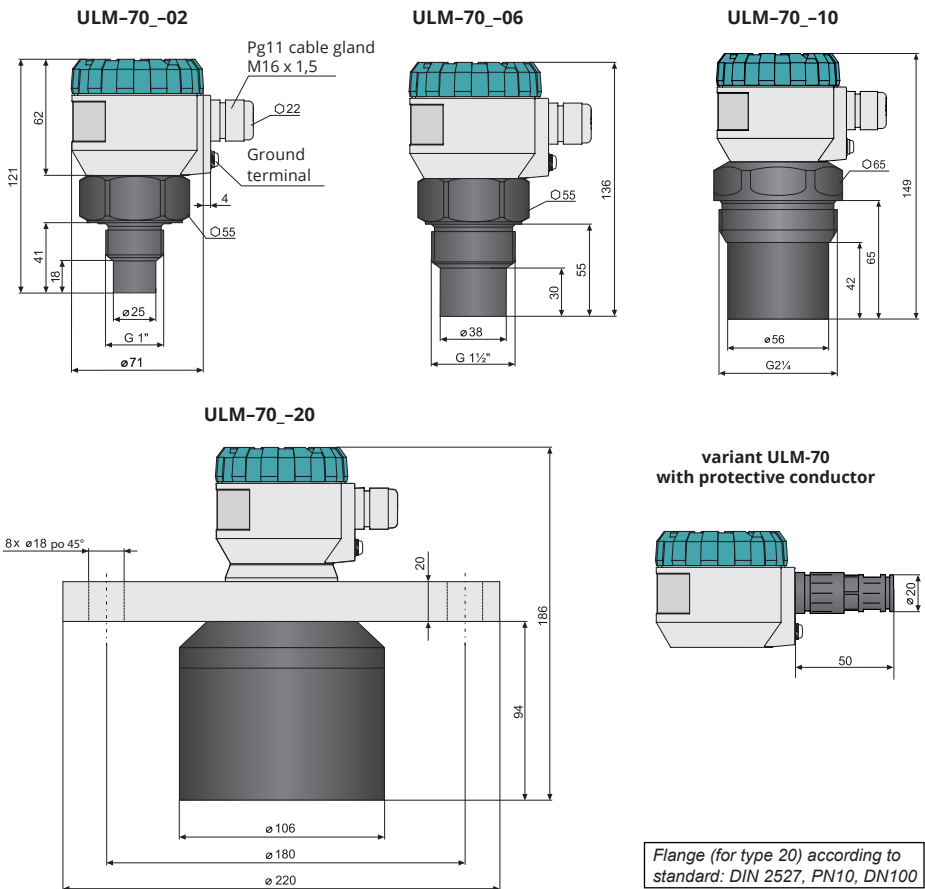

## 5. INSTALLATION AND PUTTING INTO OPERATION

Please follow next 3 steps:

- **MECHANICAL MOUNTING - SEE CHAPTER 6**
- **ELECTRICAL CONNECTION - SEE CHAPTER 7**
- **SETTINGS - SEE CHAPTER 9**

## 6. MECHANICAL MOUNTING

- Install the level meter in the **vertical position** into the upper lid of the tank or reservoir using a welding flange, a fastening nut or a flange so that the level meter axis can be perpendicular to the surface level of the measured liquid (Fig. 1).
- The min. **dimensional parameters** to install the level meter into a lid or a ceiling of a tank are given in Fig. 3.
- When installing in an **open channel** (reservoir, drain etc.), install the level meter onto a bracket as close as possible to the expected max. level.
- The reference plane for the measurement is the lower edge of the transducer (Fig.2). In connection with the measurement principle, no signals **reflected** in the area immediately under the level meter can be evaluated. **The zone** (Fig. 2) determines the min. distance possible between the level meter and the highest surface level. The min. distances to the medium are given in the chapter "Specifications".
- It is necessary to install the level meter so that the bin level cannot **interfere** with the dead zone when filled up to the maximum. If the measured level interferes with the dead zone, the level meter will not work properly.

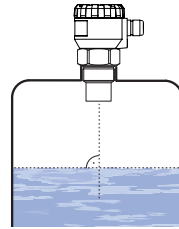

Fig. 1: Recommended installation in the tank

ULM-70-02 ; 10	$d > 1/12 c$ (min. 200 mm)
ULM-70-06	$d > 1/8 c$ (min. 200 mm)
ULM-70-20	$d > 1/10 c$ (min. 200 mm)

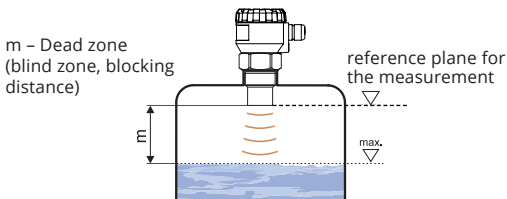

Fig. 2: Level meter dead zone

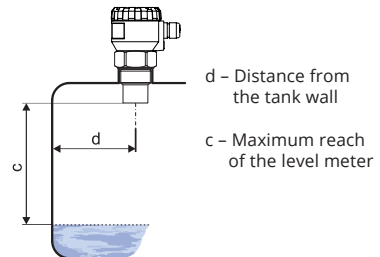

Fig. 3: Installation distance from the tank wall

- If the maximum surface level in the tank interferes with the dead zone, the level meter has to be mounted into a higher **installation neck**. In this way, the tank can be filled nearly up to the maximum volume. The inner neck surface has to be even and smooth (without edges and welded joints); the inner edge should be rounded where the ultrasonic wave leaves the pipe. The neck diameter should be as large as possible but the neck height should be as low as possible. Recommended dimensions of the input neck are given in Fig. 4.

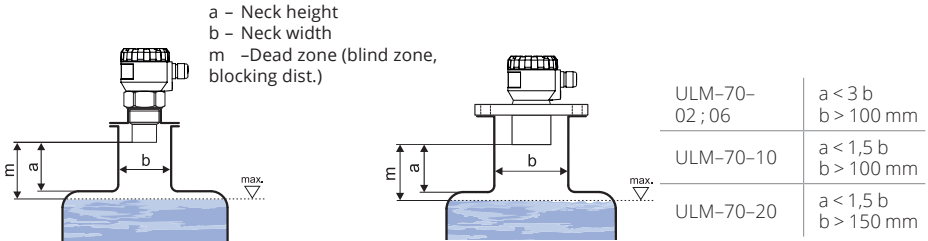

Fig. 4: Possible installation of the installation neck

- If the emitted acoustic signal of the level meter is affected by **near objects** (roughness on walls of the tank, various partitions, mixers etc.), it is necessary to map false reflections by activating the mode "TEACHING". In case of installed mixers, it is necessary to put the mixers to position under the level meter (direct the mixer paddle to the ultrasonic signal beam) (Fig. 5 and 6).

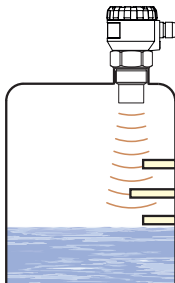

Fig. 5: False echo from obstacles in the tank

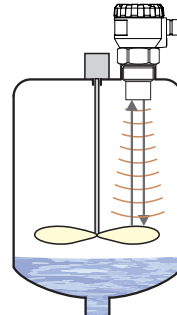

Fig. 6: False echo from the mixer paddle

- Do not install the level meter in or above the **filling** point (Fig. 7).

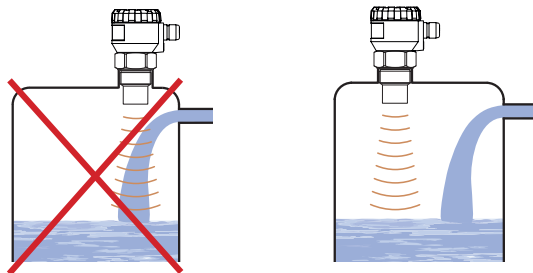

Fig. 7: Level meter installation outside the influence of filling

- In case the level of **bulk solids** is measured, the measurement range is reduced. Due to absorption of acoustic waves by a bulk medium, shortening of the measuring range occurs by up to 50% depending on the grain size. We therefore recommend selecting a level meter with greater range than the maximum range of measuring the medium. It is also appropriate to use a directional horn (see image 8), which reduces the shortening of the measuring range, because it better concentrates acoustic energy while preserving the same beam angle, and improves the sensitivity when receiving the reflected echo. We recommend to consult the use with the manufacturer.

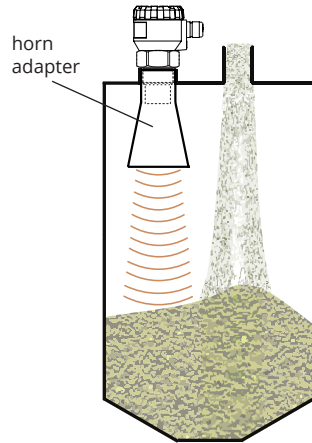

Fig. 8: Level meter installation in silo or hopper

- During filling, mixing and other processes, **foam** can arise on the surface level of the measured liquid. The foam considerably absorbs the ultrasonic signal which might cause malfunction of the level meter (Fig. 9). For such cases, it is necessary to set up "SENSITIVITY" mode to "high" or contact the manufacturer if needed. In case of a thin layer of foam, it is also possible to use the directional horn for improving receipt of the reflected echo.

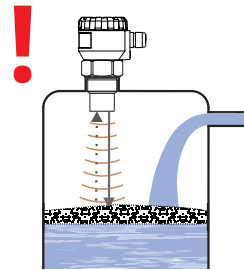

Fig. 9: Foam on the surface

- Scattering or attenuation of the ultrasonic signal can result if the surface level has been **moderately stirred** or **rippled** (by a mixer, coming liquid etc.). It can result in reduction of the measurement range or unreliable function of the level meter (Fig. 10).

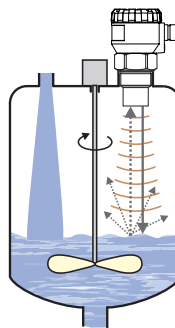

Fig. 10: Moderately stirred surface

- Rotating **mixer blades** can cause that the surface is stirred, which results in false reflections of the ultrasonic signal from the surface level and unreliable operation of the level meter (Fig. 13). **For a rippled or swirling level, you can use the directional horn to eliminate scattering of the ultrasonic signal.**

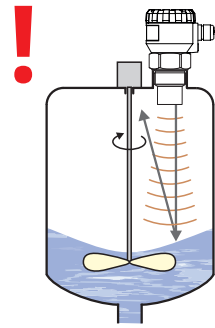

Fig. 11: Intensely stirred surface

- If the level sensor is mounted to bottlenecks and places with barriers, or near uneven walls or the filling area, where the transmission signal could be distorted, we recommend using a guide tube (acoustic horn). The tube must be made from a single material with a smooth inner surface (see image 12a, 12b ). **The minimum diameter of the pipe shall be dimension "h" as shown in the table below.** After installing, you must perform the procedure "TEACHING". We recommend consulting with the manufacture on the construction of the guide tube.

ULM-70-02	$h \geq 70$ mm
ULM-70-06	$h \geq 100$ mm
ULM-70-10	$h \geq 150$ mm
ULM-70-20	$h \geq 200$ mm

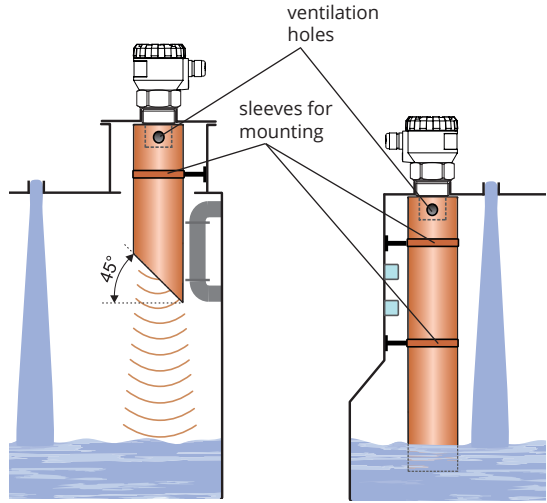

Fig. 12a: Short guide tube installation

Fig. 12b: Total guide tube installation

- The level meter must not be installed in places with direct **solar radiation** and must be protected against weather effects. If the installation in places with direct solar radiation is inevitable, it is necessary to mount a **shielding cover** above the level meter (Fig. 13).
- It is suitable to run the cable under a cable bushing (obliquely down in slack) according to Fig. 14 to prevent **penetration of humidity**. Then the rain and condensing water can flow off freely.
- The cable bushing and connector have to be **sufficiently tightened** to prevent penetration of humidity.

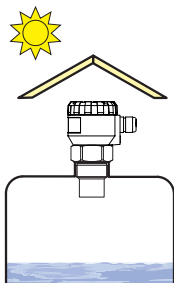

Fig. 13: Solar radiation shielding cover

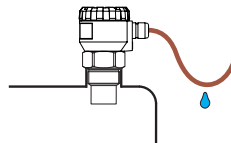

Fig. 14: Prevention to avoid intrusion of humidity



## 7. ELECTRICAL CONNECTION

The level meter is connected to consequential (evaluating) device with a suitable cable with the outer diameter of 6 to 8 mm using screw terminals located under the display module. The recommended cross section of cores for the current version  $2 \times 0,5 \div 0,75 \text{ mm}^2$  and for the version with Modbus communication  $2 \times 2 \times 0,25 \text{ mm}^2$  (twisted pair, shielded). Plus pole (+U) is connected to the terminal (+), minus pole (0 V) to the terminal (-) and the shielding (only for shielded cables) to the terminal ( $\perp$ ). Communication wires A and B of the line RS-485 (for version "M" - Modbus) are connected to the terminals A and B.

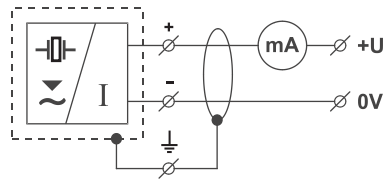

Fig. 16: Wiring diagram of the level meter with current output ULM-70\_---I

### Procedure to connect the cable to the level meter:

1. Unscrew the nut of the upper transparent lid.
2. Take the upper edge of the display module and take it out carefully by mild swinging up.
3. If you cannot grasp the module, you can use a small screwdriver. Insert it as far as the seam and use from several sides to slightly lift the module.
4. Release the cable outlet and thread the stripped supply cable in.
5. Connect the cable to the screw terminals according to the diagram in Fig. 17 or 18. Firmly tighten the terminals and the cable outlet.
6. If the level meter with Modbus is involved as a terminal for RS-485, we recommend (to avoid reflections on the line) to connect  $120\Omega$  termination resistor. This is done by moving a small lever of the switch marked  $120\Omega$  to the ON position. On the level meters connected to the line RS-485 as an intermediate device, the termination resistors are not connected (switch remains off).
7. Insert the display module back into the head so that the connector is properly connected.
8. Slide silicone seal on the thread of the level meter body, then tighten the nut of the upper lid. Connect the cable to consequential device.

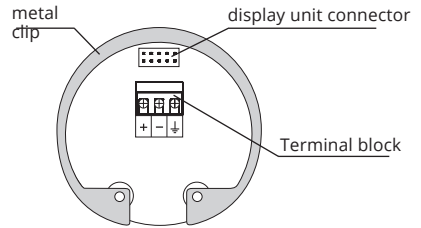

Fig. 17: Inside view of screw terminals of the level meter with current output ULM-70\_---I

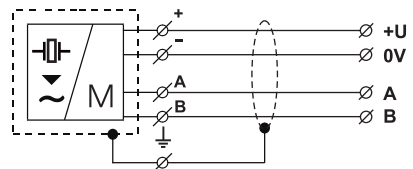

Fig. 18: Wiring diagram of the level meter with Modbus ULM-70\_---M

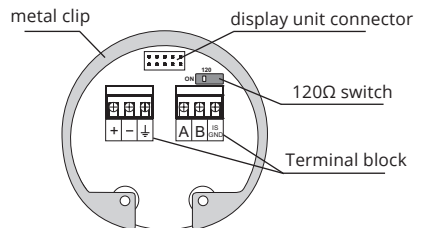

Fig. 19: Inside view of screw terminals of the level meter with Modbus ULM-70\_---M

## Data connection RS-485 / MODBUS:

Maximum distance of the module from the continuous line (length of T segment) is 3 m (fig. 35).

At the end units, it is necessary to connect terminating resistors  $R_z$  120  $\Omega$ , whilst the terminating resistors must not be connected on the continuous units (fig. 35).

The cable must be a shielded twisted pair with a core cross-section of 0.35 .. 0.8 mm<sup>2</sup> with an impedance of approximately 120  $\Omega$ .

The cable shielding is connected to a shielding clamp on the connector of line RS485 and is connected with the clamp of the PE switchboard (direct grounding) only at a single point.

In the event that the RS-485 line is lead outside of one lighting arrester, it is necessary to protect it via suitable overvoltage protection.

In the event of communication problems caused by strong interference, it is appropriate to install the system inside a metal switchboard and to install the strong interference sources (e.g. frequency converters) away from this switchboard.

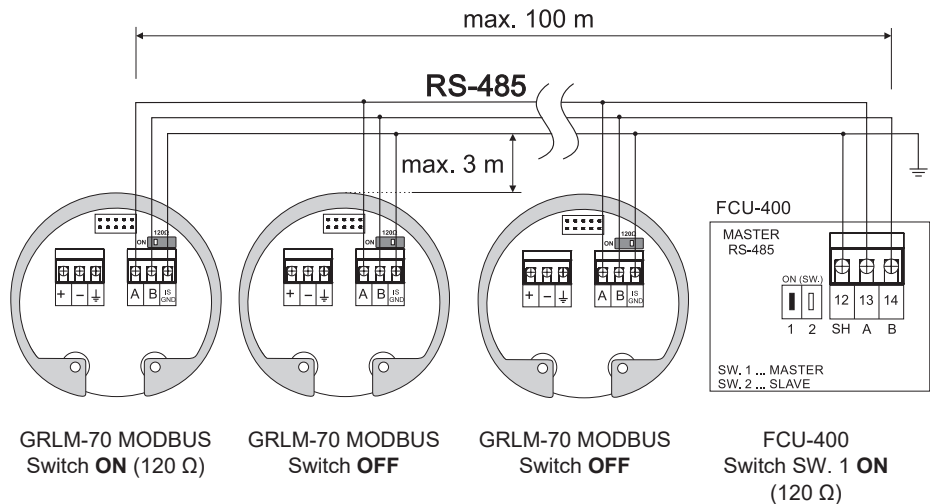

Fig. 20: Connection of multiple units via RS485 to a network



**Electrical connection can only be made when de-energized!**

The source of the power voltage must comprise of a stabilised safe low power source with galvanic separation. In the event that a switch-mode power supply is used, it is essential that its construction effectively suppresses common mode interference on the secondary side. In the event that the switch-mode power supply is equipped with a PE safety terminal, it must be unconditionally grounded! Spark-safe devices type ULM-70Xi must be powered from a spark-safe power source meeting the above-mentioned requirements.

Due to the possible occurrence of an electrostatic charge on the non-conductive parts of the sensor, it is necessary to ground all sensors intended for use in environments with an explosion hazard ULM-70Xi. This is done using the screw located on the head of the level gauge under the cable gland. Connect the screw directly at the point of installation of the level gauge to the conductive tank or to a conductive grounded structure.

In the event that the sensor is installed in an outdoor environment at a distance greater than 20 m from the outdoor switchboard, or from an enclosed building, it is necessary to supplement the electrical cable leading to the sensor with suitable overvoltage protection.



In the event of strong ambient electromagnetic interference, paralleling of conductors with power distribution, or for distribution to distances over 30 m, we recommend grounding the level meter (see above) and using a shielded cable. Ground the shielding of the cable on the side of the power supply, or the shielding is possible to connect only on inside pin of the level meter marked  $\perp$  see fig. 17 and 19 (the shielding of the cable is always connected in a single location).



Measures must also be designed and implemented in the electrical installation to reduce the effects of static electricity to a safe level.

Installation in hazardous areas must be carried out in accordance with EN 60079-14 (Electrical equipment for explosive gaseous atmospheres - Part 14: Electrical installations in hazardous areas other than mining areas) and, where applicable, in accordance with other standards that apply to the area.

## 8. EXAMPLES OF ULM-70 CONNECTION

### 8.1. WIRING DIAGRAM OF THE LEVEL METER WITH CURRENT OUTPUT AND PDU UNIT

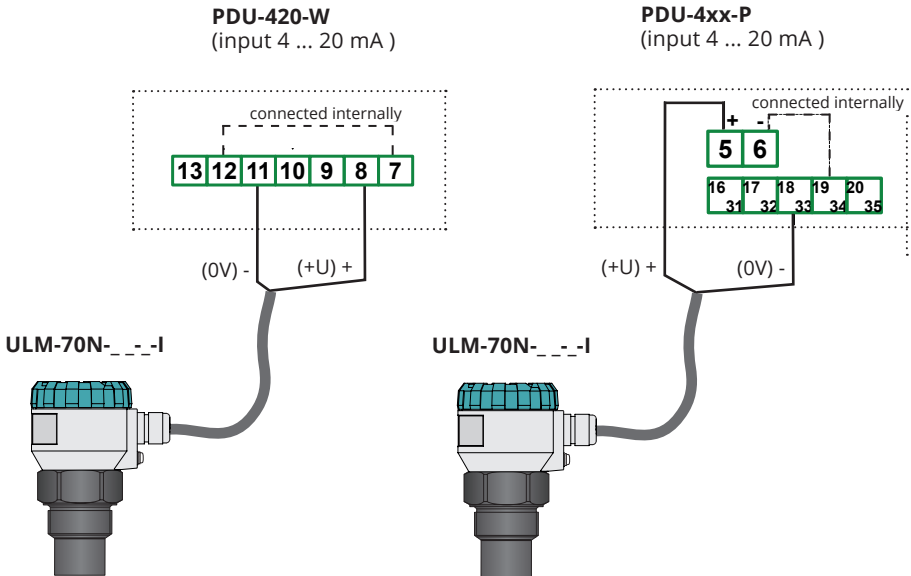

Connection of PDU-420-W is valid for firmware version 6.00 or higher. The older versions (up to version 5.99), the level meter output +U is connected to the terminal 7 and the output 0V to the terminal 10.

8.2. WIRING DIAGRAM OF THE LEVEL METER WITH CURRENT OUTPUT AND PDU UNIT IN VERSIONS FOR EXPLOSIVE AREAS

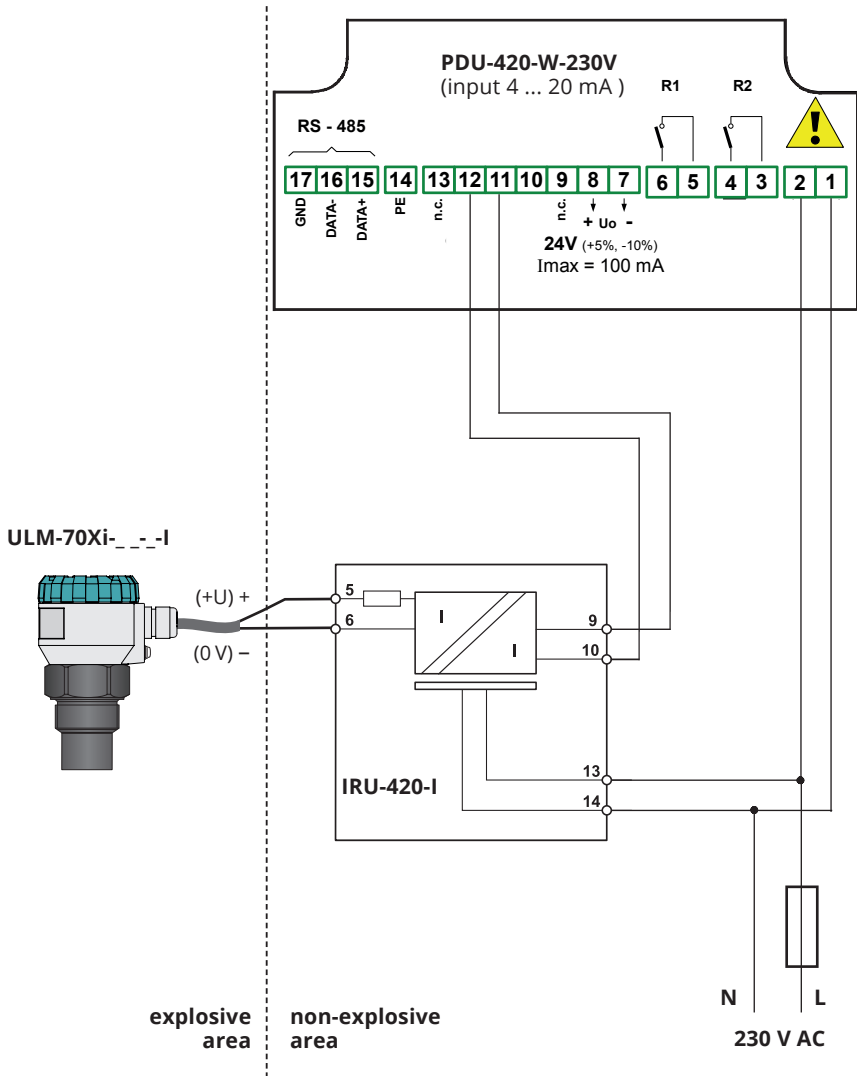

**i** Connection of PDU-420-W is valid for firmware version 6.00 or higher. The older versions (up to version 5.99), the terminal 9 of the IRU unit is connected to the terminal 10 of the PDU unit and the terminal 10 of the IRU unit is connected to the terminal 11 of the PDU unit.

**PDU-4xx-P-230V**  
(input 4 ... 20 mA)

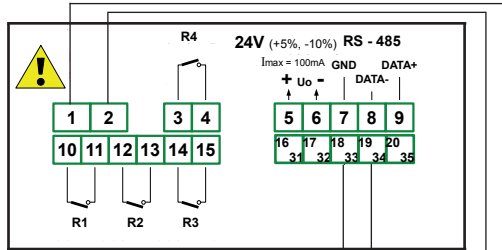

ULM-70Xi\_--\_--I

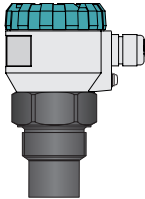

(+U) +  
(0 V) -

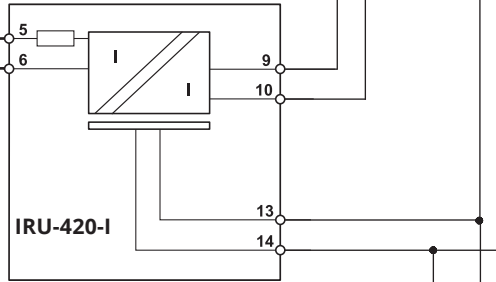

N L  
230 V AC

explosive area    non-explosive area

8.3. WIRING DIAGRAM OF THE LEVEL METER WITH CURRENT OUTPUT AND MGU UNIT

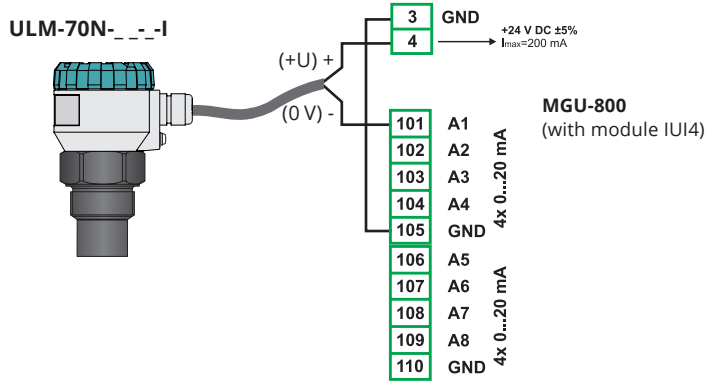

8.4. WIRING DIAGRAM OF THE LEVEL METER WITH MODBUS / RS485 AND MGU UNIT

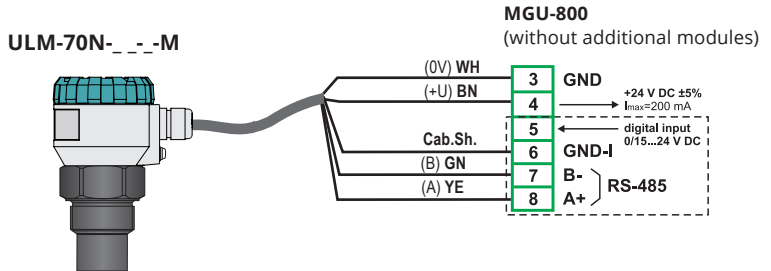

8.5. WIRING DIAGRAM OF THE LEVEL METER WITH MODBUS / RS485 AND PDU UNIT

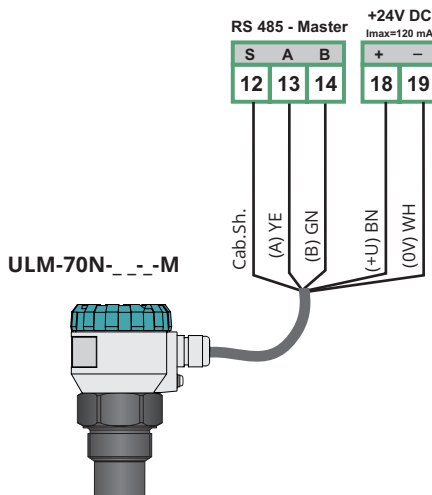

## 9. SETTING ELEMENTS

Settings are performed using 3 buttons located on the display module DM-70. All the settings are available in the menu of the level meter.

### button

- Set-up mode access
- Confirmation of selected item in the menu
- Move the cursor in the line
- Saving of set-up data

### button

- Move in the menu
- Change of values

### button

- Cancelling of carried out changes
- Shift one level up

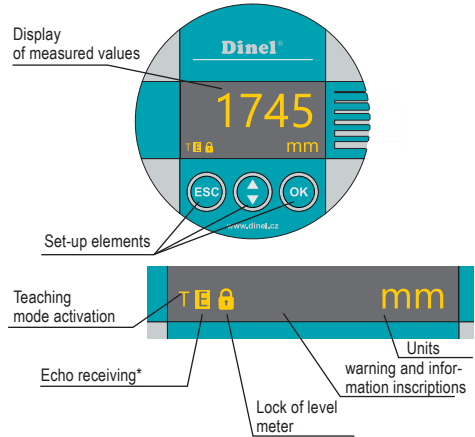

\* Slow flashing while the reflected signal (echo) is received from the measured level.

### • Status indication (left lower corner of the display):

- symbol „E“ - alternating flashing** - correct reception of the reflected wave indicating the level
- symbol „T“ - permanent shine** - "TEACHING" mode is activated
  - **inverse shine** - activation of the "TEACHING" mode
- symbol ** - **permanent shine** - the level meter is locked against unauthorized setting using a password, enter password to unlock (see MENU - PASSWORD)

### • Warning inscriptions:

- NO ECHO**
  - when tank is empty
  - after you perform the procedure TEACHING
  - level meter is not able to measure (check the media or change the sensitivity)
- FIXED OUTPUT** - the output stream is fixed to a constant value (see DIAGNOSTIC - CURRENT)
- LOW POWER** - low supply voltage (must be in the range - see Technical specifications)
- NO PASSWORD** - the level meter is protected using a password against unauthorized setting
- NO DATA AVAILABLE** - display module doesn't communicate with the electronics of the level meter (e.g. incorrectly inserted display module into connector or measuring module is not functional).

### • Information inscriptions:

- DISTANCE TO LEVEL** - the display shows the actual distance to level (see DIAGNOSTIC - DISTANCE TO LEVEL)
- CURRENT** - the display shows the output current (see DIAGNOSTIC - CURRENT)



*Level meter ULM-70\_ \_ \_ \_ \_L is supplied without the display module (display) DM-70. To setup the level meter, it is necessary to connect a display module to it (or it can be configured via HART or MODBUS). When the settings are completed, the display module may be disconnected and the level meter then measures without it.*

## 10. OPERATION AND SETTING

The level meter is manually controlled using 3 buttons located on the removable display module DM-70 (see chapter SETTINGS ELEMENTS, pg. 16). The text "SAVED" at the bottom of the display indicates that the values have been saved. Values not confirmed by pressing button **OK** will not be saved! After 5 minutes of inactivity, the level meter automatically switches back to the measuring mode. If the password is activated, the level meter will also lock itself. Once it is locked, it is not possible to make any changes to the settings. When any editing is attempted, the display will show the text "NO PASSWORD". The unlocking procedure is described on pg. 24.



After connecting the supply voltage, the display of the level meter will show the manufacturer's logo and the text "Starting" (approx. 30 s). Then the level meter switches to the measuring mode and the display shows the current measured value.

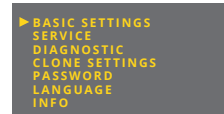

With the Modbus output variant, it is possible to setup the level meter using two-way communication via an industrial RS-485 bus with Modbus RTU protocol. The list of the respective registers is provided in a separate annex. The application "Uni SCADA level" can be used to setup the level meter and to collect measured data, and is freely available at the website [www.dinel.cz](http://www.dinel.cz).

### 10.1. BASIC CONFIGURATION

After the first start of the level meter it is necessary to perform the basic configuration (setting of the measuring range, choice of units and possibly damping). The settings are accessible in the basic menu by pressing **OK** the "BASIC SETTINGS".

#### LEVEL

Here it is possible to freely define the minimum / maximum distance of the level (item "DISTANCE TO LEVEL"). Measuring units are set in the "UNITS" menu.



UNITS: physical units of distance

ACTUAL: ACTUAL: actual distance to level

DISTANCE TO LEVEL:

MIN: defining the distance of the level meter from the minimal level

MAX: defining the distance of the level meter from the maximal level

If in the bottom of the display appears (when entering the values) the inscription "OUT OF LIMITS", the value specified for the item "DISTANCE TO LEVEL" is outside the measuring range of the level meter. If the inscription "SPAN TOO SMALL" is shown, it must be specified a larger span between MIN and MAX values.

For more information, see chapter "Specifications".

The decimal point position of the item 'LEVEL' is firmly set (according to the selected units).



1. To enter to the menu press **OK** the same button to select "BASIC SETTINGS". Then, using **↕** and **OK** select "LEVEL".
2. Now it is shown the item "LEVEL". By pressing **OK** and **↕** enter the distances of the level meter from the MIN level and for the MAX level.
3. By pressing **OK** button save the data. By next presses of the button **ESC** leave the menu. The level meter returns to measurement mode.

## SENSITIVITY

Sensitivity level meter is defined in three steps.

„LOW“ – Low sensitivity in case of surrounding interferences affecting the measurement.

„MEDIUM“ – Medium sensitivity (suitable for most applications).

„HIGH“ – Enhanced sensitivity for measured media partly absorbing the ultrasonic signal



Sensitivity can be set in three steps:  
LOW – MEDIUM – HIGH.

1. Pressing the button **OK** is for enter the menu, press the same button to select the item "BASIC SETTINGS". Then by pressing the buttons **↕** and **OK** is selected the item "SENSITIVITY".
2. Using the buttons **OK** and **↕** set the proper sensitivity.
3. After completion of setting pressing of the **OK** button saves the setting. Continue by pressing **ESC** to exit a menu and the level meter returns to the measuring mode.

## TEACHING

The mode serves for **suppressing false reflections** resulting from reflection of the ultrasonic signal from roughnesses on walls of the tank, various partitions, mixers, other obstacles. The sensor starting this mode detects false reflections and save them in the memory. Then these false reflections will not affect the subsequent measurement (they are masked). If there are no obstacles mentioned in the tank, there is no need to run this mode.



*Before starting the mode it is necessary to empty the tank as much as possible (preferably completely).*

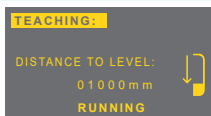
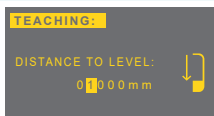
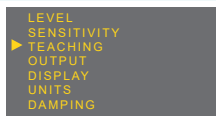

1. To enter to the menu press **OK** the same button to select "BASIC SETTINGS". Then, using **↕** and **OK** select "TEACHING".
2. Now it is shown the item "TEACHING". By pressing **OK** set the value "DISTANCE TO LEVEL" – supposed distance from the face of the sensor to the medium level. If the distance to the level is not precisely known, enter a value rather lower (in the tolerance field as shown in fig. 21).
3. After entering the "SET LEVEL DISTANCE" by pressing **OK** button the system starts "teaching" (false reflection mapping). During the mapping, the display shows flashing sign "RUNNING".
4. The mapping of false echoes can be completed when you see the inscription "Press OK to stop" and you press **OK**.
5. The procedure is completely finished when you can see the inscription "DONE". It is then possible to exit the menu by repeated pressing the button **ESC**.



If during the scanning of the tank in the bottom of the display appears the dialog "press OK to stop" (see figure) the level meter already found no further obstacles and "TEACHING" mode may be terminated. If it is not terminated, the level meter is still ready for the possible presence of obstacles (e.g. paddles of the agitator). Once it registers a further obstacle, the dialogue disappears and the obstacle is erased. This process may be repeated up to 1000 cycles. After this the "TEACHING" mode is automatically stopped.

In case of installed mixers, it is **necessary** to position the mixers under the level meter (direct the mixer blade to the ultrasonic signal beam).

Note: If there are significant obstacles in the upper half of the tank, **multiple false reflections** can occur especially in closed tanks. In such cases it is necessary to reduce the level in the tank as much as possible to correctly mask these possible multiple false reflections.

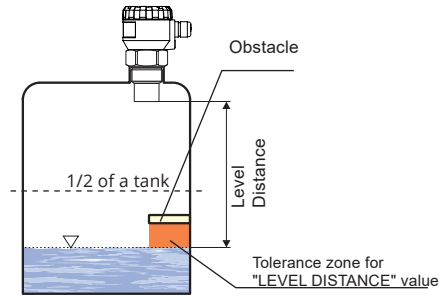

Fig. 21: Level distance zone „Set level distance“

## OUTPUT

This item is displayed only for level meters with current output and is used to convert the measured data of the level meter to current output. Limit values of current are assigned to the MIN and MAX values specified in the LEVEL item. By default, the level meter is preset so that the value of the distance to the minimum (or maximum) level is assigned a current value of 4 mA (or 20 mA).



The measuring range can also be set inversely, when the minimum of the range corresponds to a higher level of the input quantity than the maximum of the range.

1. To enter to the menu press **OK** the same button to select "BASIC SETTINGS". Then, using **UP** and **OK** select "OUTPUT".
2. Then by pressing **OK** and **UP** enter the limit values of current.
3. By pressing **OK** button save the data. By next presses of the button **ESC** leave the menu. The level meter returns to measurement mode.

## MODBUS

This item is part of a menu with Modbus output level meter ULM-70 \_-\_- M. Modbus mode is intended for the settings of the level Modbus addresses, baud rate and parity settings



ADDRESS: 1 to 247 (default 1)

BAUD RATE: 4800, 9600, 19200 (default 9600)

FORMAT : 8N1, 8O1, 8E1, 8N2 (default 8N1)

FORMAT:    — number of stop bits: 1, 2  
parita: N – non parity  
O – odd parity  
E – even parity  
data: 8 – number of bits

1. To enter to the menu press **OK** the same button to select "BASIC SETTINGS". Then, using **↑** and **OK** select "MODBUS".
2. Now the menu item "MODBUS" is shown. After pressing the button **OK** you can select by pressing **↑** parameters of the communication (ADDRESS, BAUD RATE and FORMAT). Confirmation of the mode is done with the button **OK**.
3. By pressing **OK** button save the data. By next presses of the button **ESC** leave the menu. The level meter returns to measurement mode.

## DISPLAY

This item is used to convert the measured data of the level meter to showing value on the display. Displayed limit values are assigned to the MIN and MAX values specified in the DISPLAY item. By default, the level meter is preset so that the value of the distance to the minimum (resp. maximum) level is assigned a displayed value of 0 % (resp. 100 %).



1. To enter to the menu press **OK** the same button to select "BASIC SETTINGS". Then, using **↑** and **OK** select "DISPLAY".
2. Then by pressing **OK** and **↓** enter the decimal point position of the item "DISPLAY", which is freely adjustable then by pressing **OK** and **↑** enter showed value on the display.
3. By pressing **OK** button save the data. By next presses of the button **ESC** leave the menu. The level meter returns to measurement mode.

## UNITS

Level meter can process and convert a large number of different **physical values**. The setting is done in the item "UNITS".

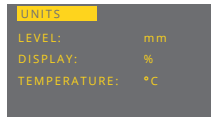

LEVEL: Unit selection (mm, cm, m, in, ft)

DISPLAY: The unit showed on the display (% , mm, cm, m, in, ft, l, hl, m<sup>3</sup>, gal, bbl, mA)

TEMPERATURE: Temperature unit (°C, °F)

1. To enter to the menu press **OK** the same button to select "BASIC SETTINGS". Then, using **↕** and **OK** select "UNITS".
2. Now the menu item "UNITS" is shown. By pressing the **OK** and **↕** button make the settings of individual items.
3. By pressing **OK** button save the data. By next presses of the button **ESC** leave the menu. The level meter returns to measurement mode.

## DAMPING

Setting the **response time** of the measurements. The function is useful for suppressing level fluctuations, waves and rapid changes of the level. The reaction time will depend on the exponential function. Damping with a defined delay in seconds represents the time when exponential reaches 2/3 of its maximum value.

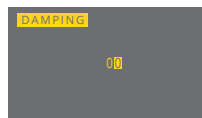
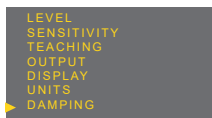

The damping time can be set in the interval from 0 to 99 s.

1. To enter to the menu press **OK** the same button to select "BASIC SETTINGS". Then, using **↕** and **OK** select "DAMPING".
2. Now the menu item "DAMPING" is shown. By pressing the **OK** and **↕** button make the settings of individual items.
3. By pressing **OK** button save the data. By next presses of the button **ESC** leave the menu. The level meter returns to measurement mode.

## 10.2. SERVICE SETTINGS

In the supplemented configuration, you can set temperature difference compensation, behaviour in case of fault conditions or HART® communication. Here, you can set the sensor into the initial state or reset it as well. The settings are accessible in the basic menu under the item "SERVICE".

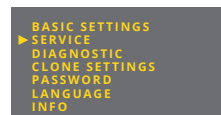

## MEDIUM TEMPERATURE

The level meter is equipped with **automatic temperature compensation**. If for instance in the tank there is a difference of 10°C between the temperature of the measured material (medium) and the temperature at the mounting site of the level meter (see the mode "DIAGNOSTICS", page 22), the measuring accuracy will be reduced by around 1% of the set range. If this function is activated, this temperature difference can be compensated. If in the tank (open channel) is a big difference between the temperature of the measured medium (liquid) and temperature in the place of installation of the ULM (see mode, "DIAGNOSTICS" page 22), it is advised to improve the precision of the measurement by the zone temperature compensation. Otherwise, this mode is **not necessary to run**.



Inactive compensation (initial state), the word "NO" appears on the display.  
See the "UNITS" menu for temperature unit selection (°C or °F).

After start of the **zone temperature compensation** mode it is necessary to set the temperature of the surface of the medium. The level meter then calculates the average value from the medium temperature and the temperature at the installation place of the level meter. With such an average temperature it counts in calculating of the velocity of acoustic waves propagation and for determination of the level position.

## FAILURE MODE

This item is a part of the level meter with a ULM-70\_ \_ \_-I current output. It defines the output current of the level meter in case of echo loss ("NO ECHO") and in case where the level of the measured substance is in the dead zone ("DEAD ZONE")

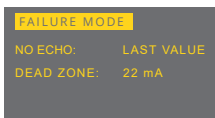
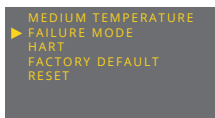

NO ECHO: Current in case of echo loss  
DEAD ZONE: Current in case of dead zone  
The values can be set in three steps:  
3,75 mA – 22 mA – LAST VALUE  
(last measured data).

## HART

This item is a part of the level meter with a ULM-70\_ \_ \_-I current output. Settings for HART® protocol (point to point, multidrop) and addresses for the multidrop mode. In multidrop mode, up to 15 devices can be connected to a single two wire cable.

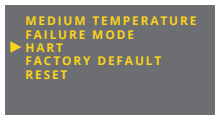



In the case of address "00", the *point to point* mode is activated. The range "01" to "15" is reserved for addresses in the *multidrop* mode (current is fixed at 4 mA).

## FACTORY DEFAULT

Load the factory default settings to the level meter. They are loaded by pressing button .

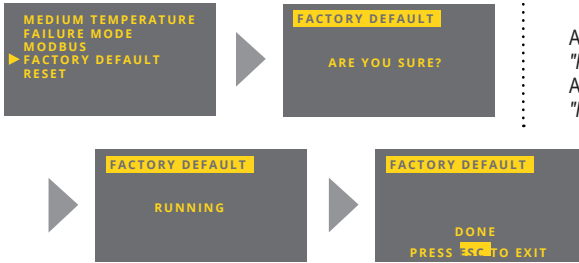
The default settings table is provided on pg. 32.



After pressing button  the message "PROCESSING" will appear for a short time. After the default values are loaded, the title "FINISHED" and text "Press Esc to exit".

## RESET

**Complete restart** of the level meter. The same effect has also a short-time interruption of the supply voltage. To enable the resetting, press the button .



During the restart process, "RUNNING" will be displayed. Then the level meter will be automatically turned off and on.

### 10.3. Additional functions

Additional functions include modes for copying settings or diagnostics. Furthermore, password protected editing, language mutations, and level meter version information (of the display module). All these functions are accessible from the main menu.

#### DIAGNOSTIC

It contains information about the actual temperature inside the tank (or about the compensated temperature) "TEMPERATURE" and current flowing through the loop "CURRENT". If the temperature compensation ("MEDIUM TEMPERATURE") is activated, the corrected temperature is displayed.

**DISTANCE TO LEVEL** : display the actual value of the distance from the sensor to the level of the measured medium.

**TEMPERATURE**: display the actual temperature measured inside the tank where the level meter is installed.

If the temperature of the measured medium is different, we recommend you to carry out the temperature compensation "MEDIUM TEMPERATURE" because of accuracy (see p. 21). Then the displayed temperature is an average value from the temperature set in the "MEDIUM TEMPERATURE" and the actual temperature measured by the sensor.

**CURRENT**: display the actual output current; only for level meter with a ULM-70 \_ \_ \_ \_I current output

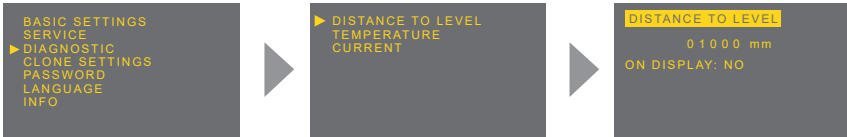

ON DISPLAY:

YES (the main display shows value from diagnostics: distance to level, temperature, current)

NO (the main display shows the standard measured value set by the DISPLAY item in the BASIC SETTINGS)

SET VALUE: setting the current to a fixed value (3,75 mA - 4 mA - 12 mA - 20 mA - 22 mA - MEASUR. )

If parameter MEASUR. is selected, current corresponds with the measured value)

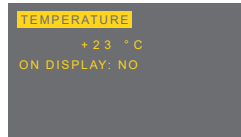

*Option SET VALUE can be used to diagnose the connected evaluation device.*

*If the current is set (fixed) to a fixed value, the main display shows the FIX OUTPUT and in section SET VALUE a title appears FIXED.*

## CLONE SETTINGS

This mode is intended for **copying** of the level meter (ULM-70 body) **configuration into the display module** (DM-70) and back. The display module can then be removed from the level meter body and put into another level meter and make there the settings transfer (cloning).

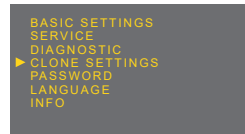

The "CLONE SETTINGS" mode transfers all data, excluding setting of the "Teaching" and HART® (POLLING ADDRESS) or MODBUS (ADDRESS).

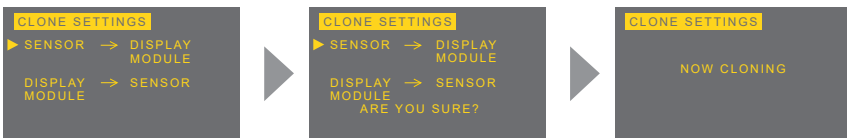

1. Press **OK** to enter the menu and select the item "CLONE SETTINGS". Copying of the settings from the body of the level meter to display module is done by selecting "SENSOR → DISPLAY MODULE". To transfer the settings from the display module to another level meter select the item DISPLAY MODULE → SENSOR.
2. The selected mode starts by pressing button **OK** . During transmission the display shows "NOW CLONING".
3. After completing the process in the middle of the screen displays "DONE". It is then possible to leave the menu and the mode by pressing the button **ESC** .



### Incompatible type of level meter.

Transfer of the settings can be realized only with the same type of level meter (e.g. ULM-70-02 - ULM-70-02, ULM-70-06 - ULM-70-06) and with the firmware version 2.0 and later.



The data set **is not stored into the display module** (DM-70). The transfer can not be done. It is necessary to repeat the procedure of the copying the settings ("SENSOR → DISPLAY MODULE").

## PASSWORD

You can lock the level meter data against unauthorized editing. After activating the password the data may be read, but can not be edited. If you try to edit the settings (without true password) the display shows "NO PASSWORD".

The password can be any 5-digit numeric combination. The combination of numbers 00000 is reserved for **disabling the password**.

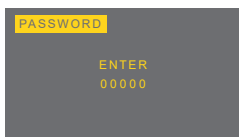
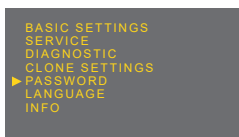

Display of status information to confirm data:

„YES“ – correctly edited password

„NO“ – incorrectly edited password

„OK“ – the password saved (only in case of "CHANGE")

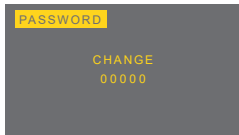

The password is automatically hidden after it is edited or changed ("00000" will appear).

To deactivate the password, edit the numerical combination "00000" in the mode "CHANGE".

1. Use the buttons and in the menu "PASSWORD" to select the mode "ENTER" for entering the password or the mode "CHANGE" for changing the password (when activated, the words are displayed inversely). Press the button once again to confirm the selection. You can change the password only when the level meter is unlocked. Otherwise, the words "NO PASSWORD" will be displayed.
2. Now you can edit the password. The actual edited item is displayed inversely. Press the button to move to the next position (clockwise direction), button serves to change the values (0 ... 9).
3. After the operation is completed, confirm the edited data by pressing the button .



*If the password is lost, contact the manufacturer.*



*The level meter with activated password will be automatically locked after 5 minutes of inactivity or after 5 min. from switching to measuring mode. Locking of level meter is indicated in the lower left corner of the screen by the symbol .*



## LANGUAGE

Setting the language of display menu.

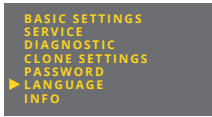

You can set five kinds of language:  
ČESKY – ENGLISH – DEUTCH – POLSKI  
– по русски

## INFO

Information about the type, serial number and production date of the level meter (type, serial number – SN and firmware version – SW).

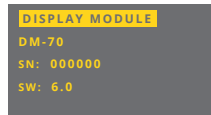
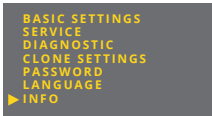

## 11. PROTOCOL HART®

Universal communication interface for data communication of peripheral devices with the level meter. Data transmission runs through the same line as the 4 ÷ 20mA current loop without impact on analog communication. For setting the level meter and collection of measured data, it is necessary to have available a HART communicator, by which it is possible to communicate directly with the level meter, or using it, to mediate communication with a peripheral device, see image 22.

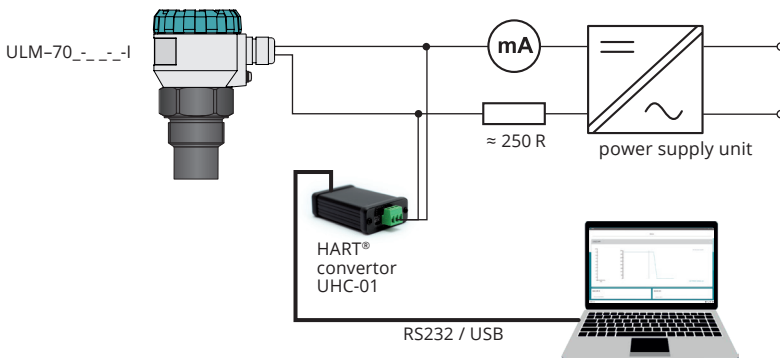

Obr. 22: Typical hardware configuration with HART

## HART® Specifications

The implemented HART® protocol is revision 5. It contains universal commands 0, 1, 2, 3, 6, 11, 12, 13, 14, 15, 16, 17, 18, 19 and standard (practical) commands 34, 35, 40, 42, 44, 49.

### Meaning of variables

PV - distance to the surface

SV - value shown on the display

TV - temperature at the measurement point

QV - level height

## 12. PROTOCOL MODBUS

---

Data communication takes place along a series line of a standard RS-485 with protocol Modbus RTU. A list of relevant variables is provided in a separate annex. To set up the level meter and collect measured data, you can use the software application "Basic SCADA level", which is freely available at the Website [www.dinel.cz](http://www.dinel.cz). Connecting the level meter to a peripheral device can be performed using a converter URC-485, see image 23.

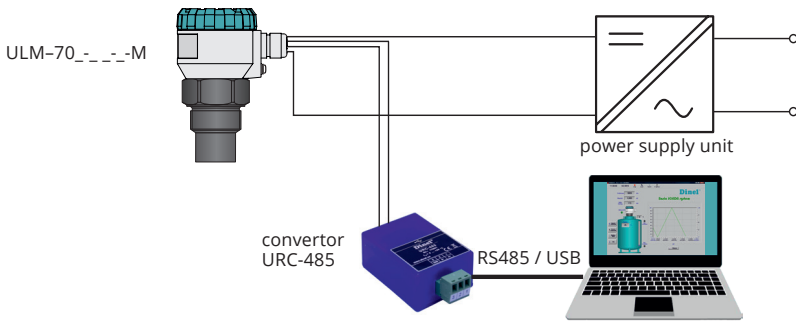

*Obr. 23: Typical hardware configuration with Modbus*

## 13. FUNCTION AND STATUS INDICATION

---

**Function and status indication are signalled by:**

- display module (see chapter 9)
- setting the fault current to the value selected in MENU - SERVICE - FAULT MODE (applies to the current version with HART® communication - **I**)
- status messages in HART® communication (valid for current version with HART® communication - **I**)
- Status registers: STATUS 1 and STATUS 2 in MODBUS communication (valid for version with MODBUS communication - **M**)

# 14. ORDER CODE

PRODUCT	
ULM-70	
PERFORMANCE	
N	Normal – usable in non-explosive areas only
Xi	Ex. proof – suitable for explosive areas
MAXIMUM REACH	
02	0,15 ... 2 m
06	0,25 ... 6 m
10	0,4 ... 10 m
20	0,5 ... 20 m
PROCESS CONNECTION	
G	thread
F	flange
OUTPUT TYPE	
I	current output (HART®)
M	RS-485 (Modbus RTU)
ELECTRICAL CONNECTION	
B1	plastic cable gland M16,
B2	plastic cable gland M20
B3	plastic cable gland M20 for 2 cables
H1	plastic cable gland for protective hose
SET-UP ELEMENTS	
D	basic version with display
C	basic version with LCD display
L	without display, metal lid
ULM-70 N - 06 - G - I - B1 - D	
EXAMPLE OF CODING	

## 15. ACCESSORIES

---

**Standard** – incl. in the price of the level sensor      **Optional** – for extra charge

- 1 pc of Seal (for ULM-70\_-02, 06, 10)
- free-to-download programme Basic Scada Level (for the Modbus version)
- Fixing nuts G1" and G1 ½" and G2 ¼
- Horn adapter ST-G1, STG1,5 and ST-G2,25
- for version Modbus convertor URC-485

## 16. SAFETY, PROTECTION, COMPATIBILITY AND EXPLOSION PROOF

---

The level meter ULM-70 is equipped with protection against reverse polarity and output current overload.

Protection against dangerous contact is secured by low safety voltage that complies with EN 33 2000-4-41.

Electromagnetic compatibility according to EN 55022/B, EN 61326/Z1 and EN 61000-4-2 to 6. Explosion proof of ULM-70Xi type complies with the following standards: EN 60079-0 : 2007; EN 60079-11 : 2007 ; EN 60079-26 : 2007 and examined by FTZÚ-AO 210 Ostrava - Radvanice certificate No.: FTZÚ 09 ATEX 0277X.

### **Special conditions for safe use ULM-70Xi:**

The device is designed for connection to the isolating repeater IRU-420. When the other approved supply unit is used, whose output parameters satisfy above mentioned output parameters, it is necessary to have a galvanic separation or, if supply unit without galvanic separation is used (Zener barriers), it is necessary provide potential equalization between sensor and point of barrier earthing.

For application in zone 0 the present explosive atmospheres - mixture of air with flammable gases, vapour or mists must comply:  $0,8 \text{ bar} < p < 1,1 \text{ bar}$ . The device must be installed in such a way, to prevent mechanical damage of sensor face. It is necessary carried out earthing by screw which is placed on head of level meter.



**The device must be installed in such a way, to prevent mechanical damage of sensor face.**

## 17. USE, MANIPULATION AND MAINTENANCE

The level meter does not require any personnel for its operation. Follow-up displaying device is used to inform the technological entity operating personnel on the measured substance level height during the operation.

Maintenance of this equipment consists in verification of integrity of the level meter and of the supply cable. Depending on the character of the substance measured, we recommend to verify at least once per year the clarity of the ultrasound transducer emitting field and to clean it, respectively. In case any visible defects are discovered, the manufacturer or reseller of this equipment must be contacted immediately.



It is forbidden to perform any modifications or interventions into the ULM-70 level meter without manufacturer's approval. Potential repairs must be carried out by the manufacturer or by a manufacturer authorized service organization only.

Installation, commissioning, operation and maintenance of the ULM-70 level meter has to be carried out in accordance with this instruction manual; the provisions of regulations in force regarding the installation of electrical equipment have to be adhered to.

Installation in areas with potentially explosive atmospheres must be carried out in accordance with standard EN 60079-14 (Electrical apparatus for explosive gas atmospheres - Part 14: Electrical installations in hazardous areas other than mines) and respectively in accordance with other standards that apply to a given area.

The device must be installed to prevent tensile overload rope electrode level meter.

## 18. MARKING OF LABELS

Labels for type of ULM-70N-\_\_-I-\_\_-:

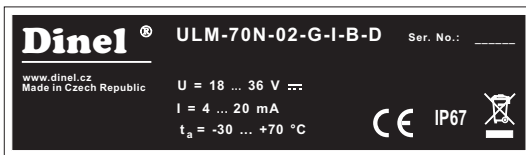

Example of label for type of ULM-70N-02-G-B-D

Symbol of producer: logo Dinel®

Internet address: [www.dinel.cz](http://www.dinel.cz)

Level meter type: ULM-70N-\_\_-I-\_\_-

Serial number: Ser. No.: xxxxx - (from the left: production year, serial production number)

Supply voltage:  $U_i = 18 \dots 36 \text{ V}$

Output current range:  $I = 4 \div 20 \text{ mA}$

Ambient temperature range:  $t_a = -30 \dots \_ \_ \text{ °C}$  (see. Temperature range according to type)

Protection class: IP67

Compliance mark: **CE**

Electro-waste take-back system mark:

Temperature range according to type:

02	$t_a = -30 \dots +70 \text{ °C}$
06	$t_a = -30 \dots +70 \text{ °C}$
10	$t_a = -30 \dots +60 \text{ °C}$
20	$t_a = -30 \dots +60 \text{ °C}$

## Labels for type of ULM-70Xi-\_-\_-I-\_-\_- :

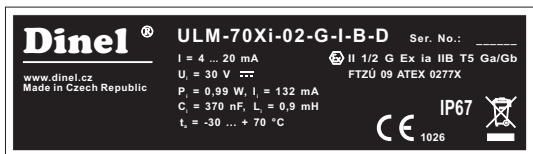

Example of label for type of ULM-70Xi-02-G-I-B-D

Classification non-explo-  
sive performance:

02	II 1/2G Ex ia IIB T5 Ga/Gb
06	II 1/2G Ex ia IIB T5 Ga/Gb
10	II 1/2G Ex ia IIA T5 Ga/Gb
20	II 2G Ex ia IIA T5 Gb

Symbol of producer: logo Dinel®

Internet address: www.dinel.cz

Level meter type: ULM-70Xi-\_-\_-I-\_-\_-

Serial number: Ser. No.: xxxxx -

(from the left: production year, serial production number)

Output current range: I = 4 ... 20 mA

Max. internal values:  $U_i = 30 \text{ V}$ ,  $I_i = 132 \text{ mA}$ ;  $P_i = 0,99 \text{ W}$ ;  $C_i = 370 \text{ nF}$ ;  $L_i = 0,9 \text{ mH}$

Ambient temperature range:  $t_a = -30 \dots +70 \text{ °C}$  (viz. Teplotní rozsah dle typu)

Label of non-explosive device: , Performance: II\_G Ex ia II\_T5 /\_

Number of certificate of intrinsically safety: FTZÚ 09 ATEX 0277X

Protection class: IP67

Compliance mark: **CE**, No. of authorized person examining control of system quality: 1026

Electro-waste take-back system mark:

Temperature range  
according to type:

02	$t_a = -30 \dots +70 \text{ °C}$
06	$t_a = -30 \dots +70 \text{ °C}$
10	$t_a = -30 \dots +60 \text{ °C}$
20	$t_a = -30 \dots +60 \text{ °C}$

## Labels for type of ULM-70N-\_-\_-M-\_-\_- :

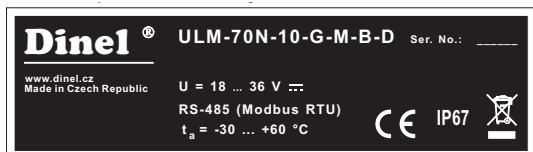

Example of label for type of ULM-70N-10-G-M-B-D

Temperature range  
according to type:

02	$t_a = -30 \dots +70 \text{ °C}$
06	$t_a = -30 \dots +70 \text{ °C}$
10	$t_a = -30 \dots +60 \text{ °C}$
20	$t_a = -30 \dots +60 \text{ °C}$

Symbol of producer: logo Dinel®

Internet address: www.dinel.cz

Level meter type: ULM-70N-\_-\_-I-\_-\_-

Serial number: Ser. No.: xxxxx - (from the left: production year, serial production number)

Supply voltage:  $U = 18 \dots 36 \text{ V}$

Data output: RS-485 (Modbus RTU)

Ambient temperature range:  $t_a = -30 \dots +70 \text{ °C}$  (see. Temperature range according to type)

Protection class: IP67

Compliance mark: **CE**

Electro-waste take-back system mark:

Real label size is 70x20mm.

## 19. TECHNICAL SPECIFICATIONS

TECHNICAL SPECIFICATIONS – LEVEL METER		
Measuring range <sup>1)</sup>	ULM-70_-02	0.15 ... 2 m
	ULM-70_-06	0.25 ... 6 m
	ULM-70_-10	0.4 ... 10 m
	ULM-70_-20	0.5 ... 20 m
Adjustable measuring range (SPAN)		Min. 200 mm
Supply voltage	ULM-70N-__	18 ... 36 V DC
	ULM-70Xi-__	18 ... 30 V DC
Output	ULM-70-_-_-I ULM-70-_-_-M	4 ... 20 mA (Limit values 3.9 ... 20.5 mA), HART® RS-485 with protocol Modbus RTU
Current consumption	ULM-70-_-_-I ULM-70-_-_-M	4 ... 20 mA / Max. 22 mA Max. 20 mA
Resolution	ULM-70_-02; 10	< 1 mm
	ULM-70_-06	< 2 mm
	ULM-70_-20	< 2.5 mm
Accuracy (within the total range)		0.15 %
Temperature error		Max. 0.04% / K
Operating frequency	ULM-70_-02	120 kHz
	ULM-70_-06	75 kHz
	ULM-70_-10	50 kHz
	ULM-70_-20	30 kHz
Beamwidth (-3 dB)	ULM-70_-02; 10	10°
	ULM-70_-06	14°
	ULM-70_-20	12°
Ambient temperature range	ULM-70_-02; 06	-30 ... +70 °C
	ULM-70_-10; 20	-30 ... +60 °C
Short-time temperature stress resistance		+90 °C / 1 hour
Max. operation overpressure (on transmission surface)		0.1 MPa
Sensitivity		3 steps (low – medium – high)
Damping		0 ... 99 s
Measuring period		1 ... 4 s
Rise time		ca. 30 s
Additional technical data for Ex proof <sup>2)</sup> – Max. internal values		U <sub>i</sub> =30 VDC; I <sub>f</sub> =132 mA; P <sub>i</sub> =0.99 W; C <sub>i</sub> =370 nF; L <sub>i</sub> =0.9 mH
Failure indication (echo loss, level in dead zone <sup>3)</sup> , internal failure)		Adjustable in modes: 3.75 mA; 22 mA; Last measured value
Maximal resistance of current output load (U = 24 VDC)		R <sub>max</sub> = 270 Ω <sup>4)</sup>
Mechanical connection	ULM-70_-02	Screwing with thread G 1"
	ULM-70_-06	Screwing with thread G 1½"
	ULM-70_-10	Screwing with thread G 2¼"
	ULM-70_-20	Aluminium alloy flange

<sup>1)</sup> In case the level of bulk-solid materials is measured, the measurement range is reduced.

<sup>2)</sup> Allowed pressure range in the zone 0: 80 ... 110 kPa.

<sup>3)</sup> Dead zone = Blind zone = Blocking distance

<sup>4)</sup> Including 250Ω resistor in case of HART® connection.

## TECHNICAL SPECIFICATIONS – LEVEL METER

Protection class		IP67
Weight	ULM-70_-02	0.3 kg
	ULM-70_-06	0.4 kg
	ULM-70_-10	0.6 kg
	ULM-70_-20	3.1 kg

## TECHNICAL SPECIFICATIONS – DISPLAY MODULE

Display type		Matrix OLED, LCD <sup>1)</sup>
Resolution		128 x 64 pixel
Character height / Number of digits measured value		9 mm / 5 Digits
Display colour	OLED	Yellow
	LCD	black with white background light
Buttons		Membrane switch panel
Ambient temperature range	OLED	-30 ... +70 °C
	LCD	-20 ... +70 °C
Weight		46 g

1) OLED- suitable for indoor and low-light applications. LCD – suitable for outdoor applications particularly with direct sunlight.

## USED MATERIALS

Sensor part	Variants	Standard material
Lid	All types	aluminium alloy with powder coating
Glass	All types	polycarbonate
Body	All types	aluminium alloy with powder coating
Housing with thread	All types	plastic PP
Electroacoustic converter	All types	plastic PVDF
Display module	ULM-70_...-D (with display)	plastic POM
Cable gland	All types	plastic PA
Flange	ULM-70-20-F	aluminium alloy with powder coating

## FACTORY DEFAULT

	ULM-70_-02	ULM-70_-06	ULM-70_-10	ULM-70_-20
MIN LEVEL <sup>1)</sup>	2 000	6 000	10 000	20 000
MAX LEVEL <sup>2)</sup>	150	250	400	500
UNITS	mm; %; °C	mm; %; °C	mm; %; °C	mm; %; °C
DAMPING	2	5	10	10
SENSITIVITY	MEDIUM	MEDIUM	MEDIUM	MEDIUM
MEDIUM TEMPERATURE	NO	NO	NO	NO
FAILURE MODE – NO ECHO	3.75 mA	3.75 mA	3.75 mA	3.75 mA
FAILURE MODE – DEAD ZONE <sup>3)</sup>	22 mA	22 mA	22 mA	22 mA
POOLING ADDRESS (HART®)	00	00	00	00
PASSWORD	No password	No password	No password	No password

<sup>1)</sup> Distance to min. level

<sup>2)</sup> Distance to max. level

<sup>3)</sup> Dead zone = Blind zone = Blocking distance



## AREA CLASSIFICATION (according to EN 60079-10 and EN 60079-14)

ULM-70N-__	Performance for non-explosive areas
ULM-70Xi-02 ULM-70Xi-06	Explosive proof – suitable for explosive areas (combustible gases or vapours) ⊕II 1/2G Ex ia IIB T5 Ga/Gb with JBIP <sup>1)</sup> , the whole level meter – zone 1, front head part – zone 0
ULM-70Xi-10	Explosive proof – suitable for explosive areas (combustible gases or vapours) ⊕II 1/2G Ex ia IIA T5 Ga/Gb with Isolating repeater (IRU-420), the whole level meter – zone 1, front head part – zone 0
ULM-70Xi-20	Explosive proof – suitable for explosive areas (combustible gases or vapours) ⊕II 2G Ex ia IIA T5 Gb with Isolating repeater (IRU-420), the whole level meter – zone 1

1) Intrinsically safe isolation converter (e.g. Dinel IRU-420).

## 20. PACKAGING, SHIPPING AND STORAGE

The device DLM-35 is packaged in a polyethylene bag, and the entire consignment is placed into a cardboard box. A suitable filler material is used in the cardboard box to prevent mechanical damage during transport. Remove the device from the packaging only just before using, thereby protecting it from potential damage.

A forwarding company will be used to ship goods to the customer. Upon prior agreement, ordered goods can be picked up in person at company headquarters. When receiving, please check to see that the consignment is complete and matches the order, or to see if any damage has occurred to the packaging and device during transport. Do not use a device clearly damaged during transport, but rather contact the manufacturer in order to resolve the situation.

If the device is to be further shipped, it must be wrapped in its original packaging and protected against impact and weather conditions.

Store the device in its original packaging in dry areas covered from weather conditions, with humidity of up to 85 % without effects of chemically active substances. The storage temperature range is -20°C to +60°C.



**Level gauges (sensors) of ULM-70 - 02, 06, 10, 20 type variants are equipped with protective caps to prevent damage to the ultrasonic sensor. The cover must be removed during operation! If possible, remove the cover after installation. If the technology does not allow it, remove the cap just before installation. Store the cover after removal! If the level gauge (sensor) has to be handled again, the cap must be placed back on. If handling without the protective cap is detected, the level gauge/sensor will be regarded as mechanically damaged.**

# 19. MENU STRUCTURE

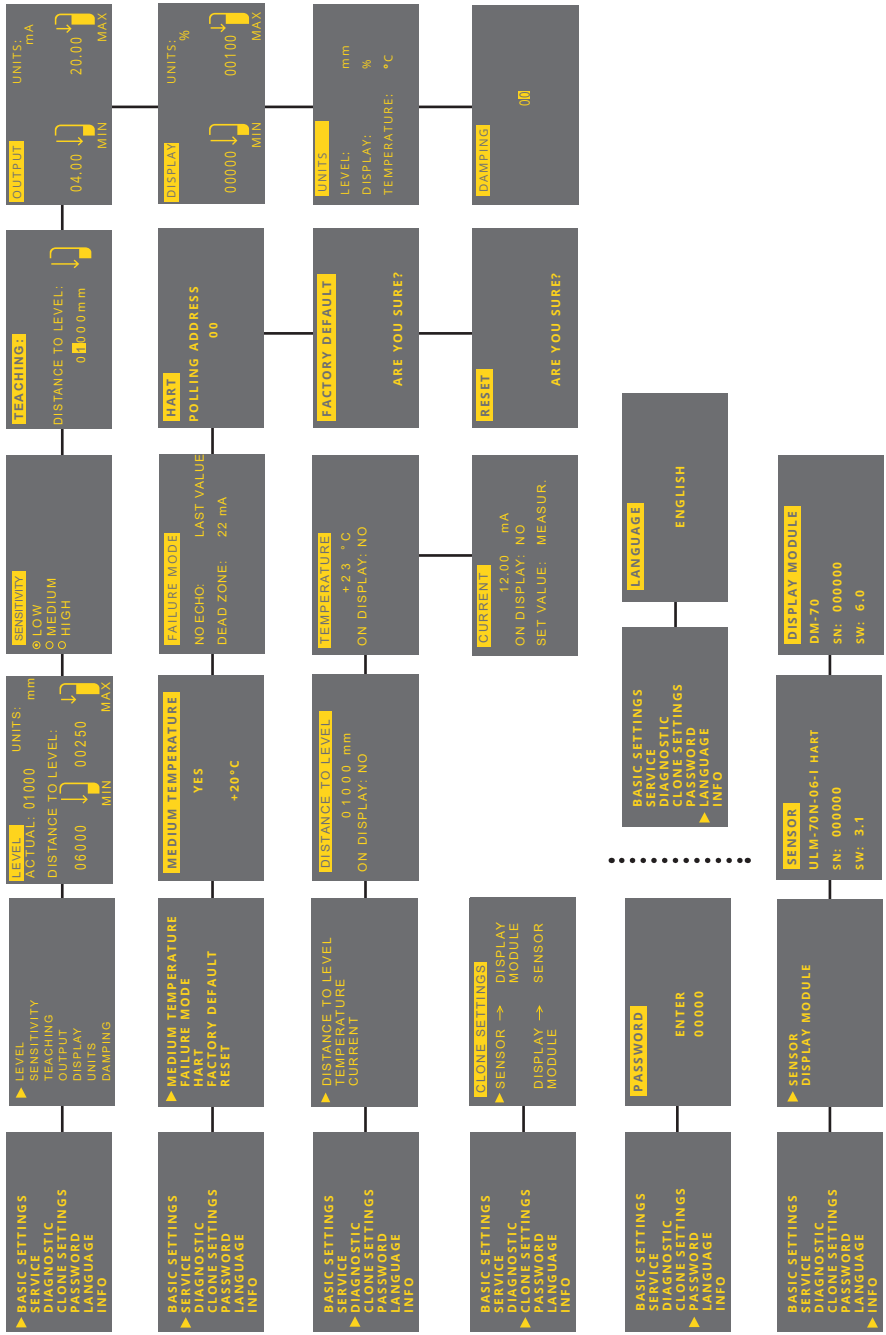



# Dinel<sup>®</sup>

industrial electronics

**Dinel, s. r. o.**  
U Tescomy 249  
760 01 Zlín  
Czech Republic

phone: +420 577 002 002  
e-mail: [sale@dinel.cz](mailto:sale@dinel.cz)

[www.dinel.cz](http://www.dinel.cz)

*This project was realised under financial support from the funds of the state budget through the "Department of Trade and Industry".*

Find the updated version at [www.dinel.cz](http://www.dinel.cz)

version: 01/2025

