

RFLS-24

Dinel®

HIGH-FREQUENCY LEVEL SENSOR

with elimination of deposits and
foam on electrode in a compact
design



CE



MIN
-40°C



- For reliable limit-level sensing of various liquids, slurries and pastes
- Resistant to adhesion of viscous and sticky media (ketchup, yoghurts, spreads, syrups, creams, pastes, cleaning agents, etc.)
- Replacement for vibrating level sensors
- Adjustment by magnetic pen or programming wire
- Universal design for all types of media (electrically conductive and non-conductive)
- High stability at high sensitivity (can be used for substances with $\epsilon_r \geq 1.5$)
- The unique design of the electrode system does not require an additional internal seal (O-ring)

TECHNICAL PARAMETERS

supply voltage	7 ... 34 V DC
current consumption	max. 5 mA DC
output type	PNP (open collector)
max. switching current (PNP output)	300 mA
Process temperature range at the process connection point	-40 ... +105 °C
maximum overpressure (relative)	-40 °C ... +75 °C -1 ... 100 bar +75 °C ... +105 °C -1 ... 50 bar
process connection	thread G ½, NPT ½
electrical connection	connector M12
protection class	IP 68
weight (without cable)	approx. 0,15 kg

MATERIALS

housing	stainless steel W. Nr. 1.4404 (AISI 316L)
electrode insulation	PEEK
connector M12 - CP	polycarbonate
connector M12 - CM	stainless steel W. Nr. 1.4404 (AISI 316L)

BASIC FEATURES AND VARIANTS

The RFLS-24 high-frequency level sensor is designed for industrial use in limit sensing of liquid and pasty media. It can serve as direct replacement for a vibrating level sensor, or a capacitive level sensor for more demanding applications. Media can be electrically conductive or non-conductive with any permittivity.

It can be installed in metal or plastic tanks, filling tanks, sumps, etc.

The sensor is available with a standard (type 1) or extended (type 11) electrode section in combination with a plastic (CP) or stainless steel (CM) connector.

VARIANTS	
code	type of sensor
RFLS-24_1-___-CP	insulated electrode (PEEK) , for sensing various liquids, slurries and pastes, also suitable for oils. Plastic connector with LED indication allows adjustment even with a magnetic pen and visual check of sensor functionality
RFLS-24_11-___-CP	insulated electrode (PEEK) extended electrode , for sensing various liquids, slurries and pastes, also suitable for oils. Plastic connector with LED indication allows adjustment even with a magnetic pen and visual check of sensor functionality
RFLS-24_1-___-CM	insulated electrode (PEEK) , for sensing various liquids, slurries and pastes, also suitable for acids or bases. Hardened stainless steel version of the connector (without LED indication) is designed for more demanding conditions, setting with a programming cable is recommended
RFLS-24_11-___-CM	insulated electrode (PEEK) extended electrode part , for sensing various liquids, slurries and pastes, also suitable for acids or bases. Hardened stainless steel version of the connector (without LED indication) is designed for more demanding conditions, setting with programming wire is recommended

USE

RFLS-24 level sensor can be mounted horizontally or diagonally in a vessel, tank or pipe shell by screwing into a sleeve or by attaching with a nut. Basic application recommendations are listed below.

Thanks to its design, the sensor is suitable for level detection of viscous and electrically conductive media (yoghurt, marmalades, mayonnaise, spreads, liquid soaps, creams or pastes). After setting the sensitivity to the medium, the sensor reacts reliably to the presence or absence of the medium level. Conversely, the sensor does not react to residues and deposits of viscous media on the measuring electrode.

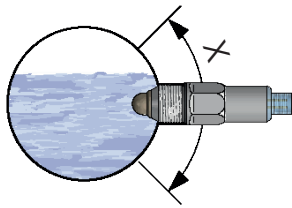

X = Recommended orientation for installation of sensors in pipes

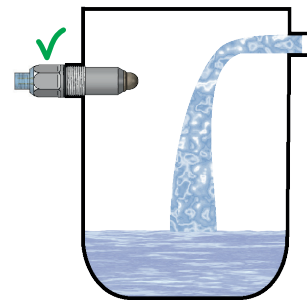



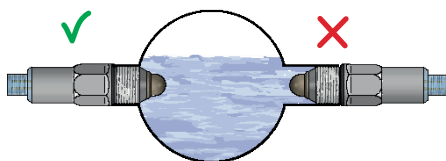

Correct orientation of sensor installation in tanks

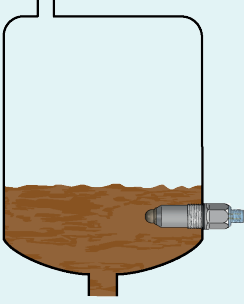
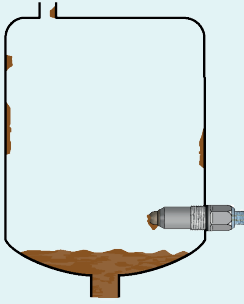
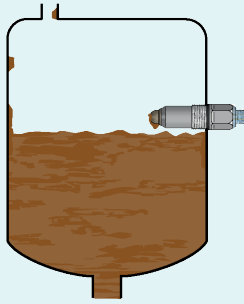
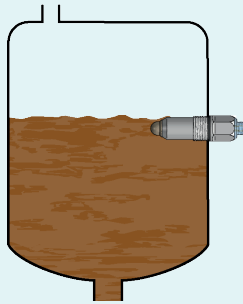

Correct and incorrect installation of the sensor into the pipe fitting

Setting modes

The sensor can be set to normally closed "O-mode" or to normally open "C-mode" switch types.

minimum level - mode O		maximum level - mode C	
			
closed	open	closed	open
			
illuminated*	not illuminated*	illuminated*	not illuminated*

For safety reasons, we recommend using the „O“ mode setting for sensing the minimum level (the sensor switches on when flooded). A failure of the sensor or wiring will be indicated here as an emergency level condition by disconnecting the sensor.

By analogy, for max. level, we recommend setting the mode „C“ (the sensor switches off when flooded).

*LED indication only for CP variant, not valid for CM

DIMENSIONS

RFLS-24N-1

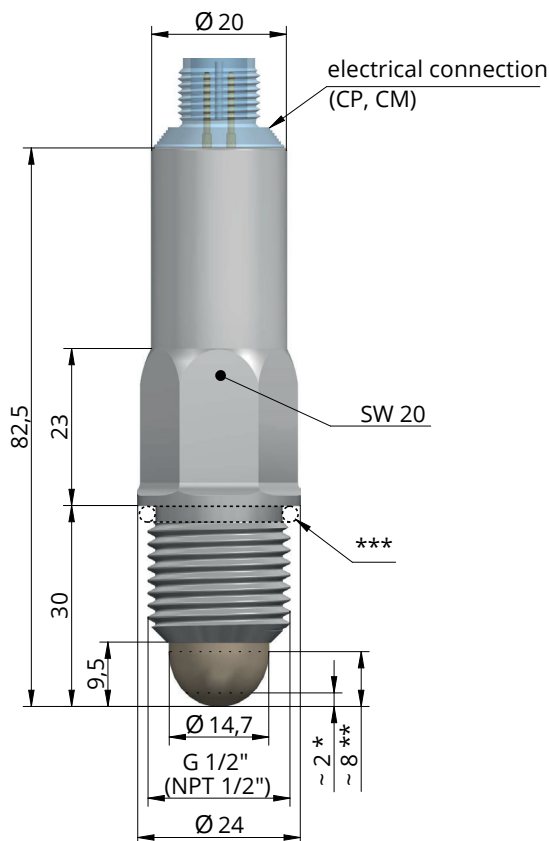

RFLS-24N-11

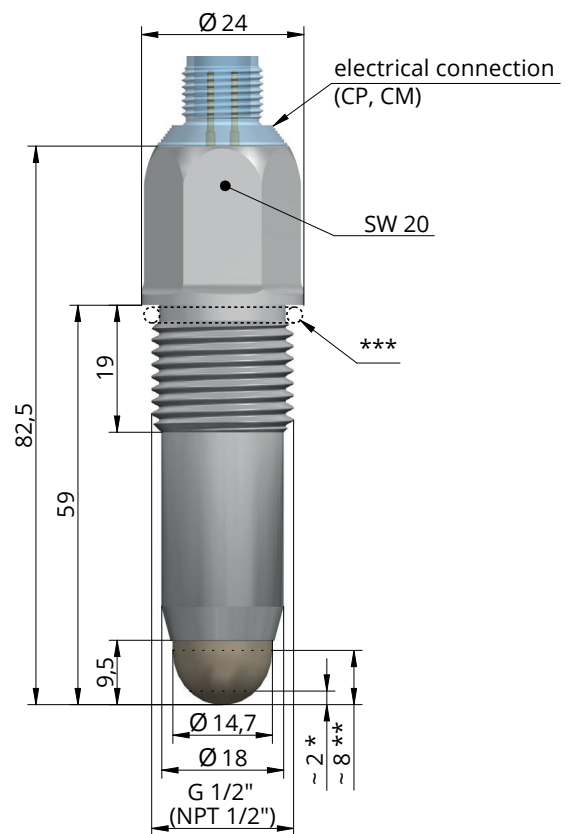

* Typical switching point position for water (factory setting)

** Typical switching point position for oil (factory setting)

*** Supplied without gasket as standard

ELECTRICAL CONNECTION

RFLS-24N-_-_-CP

RFLS-24N-_-_-CM

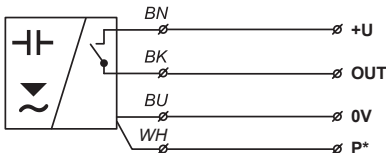
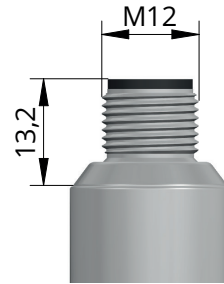
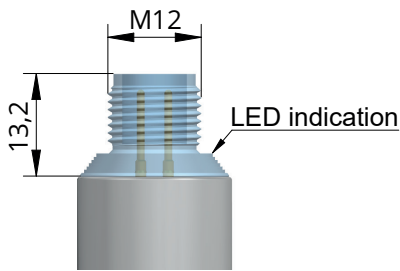

Wiring of RFLS-24 sensor with PNP Output
* Programming wire

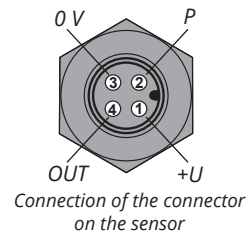

Legend:
BK - black (OUT)
BN - brown (+U)
BU - blue (0V)
WH - white (P)

SETTING AND DISPLAY ELEMENTS

Setting elements

Used to adjust the sensitivity and behaviour of the sensor.

1) Locally using a magnetic pen (CP variant)

which is attached to the magnetically sensitive ON or OFF spots on the sensor.

2) Remotely by programming wire (CP and CM variant)

via the DSU-1222-AP power supply unit. Remote parameterization allows the same setting options as the magnetic pen setting.

Display elements (CP variant)

Used to display the sensor status.

1) Green LED

flashing - (approx. 0.4 sec.) - correct level detection function
not illuminated - incorrect installation or malfunction

2) Orange LED

illuminated - the sensor is closed
not illuminated - the sensor is open
3 short flashes - confirmation of setting

alternating flashing of green and orange LEDs - setting error

simultaneous illumination of green and orange LEDs - during the application of the mag. pen when the setting is confirmed

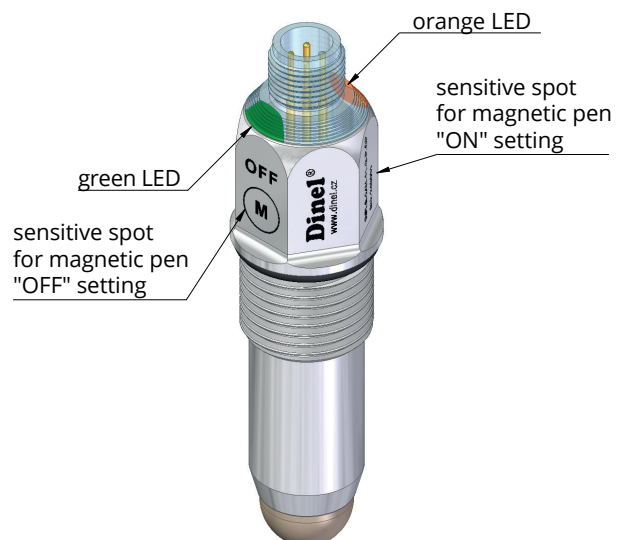

ORDER CODE

RFLS-24

PERFORMANCE

N non-explosive areas

ELECTRODE TYPE

1 coated electrode (PEEK)

11 coated electrode (PEEK) - extended electrode section

PROCESS CONNECTION*

G front installation, thread G ½

NPT front installation, thread NPT ½

OUTPUT TYPE

P PNP (open collector)

TYPE OF ELECTRICAL CONNECTION

CP standard plastic connector, thread M12 (LED indication)

CM standard stainless steel connector, thread M12 (hardened variant)

RFLS-24 N - 11 - G - P - CP EXAMPLE OF CODING

* Supplied without gasket as standard

RECOMMENDED POWER SUPPLY AND DISPLAY UNIT

power supply of sensors, converting their status to power contact and remote parameterization

at extra cost

DSU-1222-AP



ACCESSORIES

magnetic pen (1 pc)
(CP variant only)

included in the price

MP-8



disassemble socket

at extra cost

ELKA 4012



disassemble socket

at extra cost

ELWIKA 4012



cable with ELWIKA connector
three-core without programming wire option

at extra cost

KV 4312



cable with ELWIKA connector
four-core with programming wire option

at extra cost

KV 4412



different types of seals:
o-rings (EPDM, FPM, NBR)
USIT rings (FPM, NBR)
aluminium seals

at extra cost



weld flange G 1/2

at extra cost



fixing nut G 1/2

at extra cost

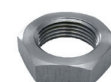

Dinel, s.r.o.
U Tescomy 249, 760 01 Zlín
tel.: +420 577 002 000
e-mail: sale@dinel.cz

www.dinel.cz

version:
11/2024

