

QOS-35

Dinel®

OIL QUALITY SENSOR

based on permittivity measurement principle



- **QOS-35 detects any and all wear and contamination: water, acid, fuel, viscosity, different oil types, carbon, particles, etc.**
- **Working principle - dielectric constant (ϵ_r) measurement**
- **Robust design that resists clogging by dirt**
- The sensor is equipped with temperature compensation of the temperature drift permittivity of the oil
- Continuously analyzes oil condition in operating equipment
- Easy to run and adjust the sensitivity of the sensor by a magnetic pen
- Universal design for all types of oil
- Compact performance for quick and easy to install on any equipment

TECHNICAL SPECIFICATIONS

supply voltage	12 ... 34 V DC
voltage output	0 ... 10 V DC
status indication	2x LED (orange, green)
ϵ_r temperature drift compensation	$+9.6 \times 10^{-4} / ^\circ\text{C}$
ϵ_r range - high sens.	$-0.01 \dots \epsilon_{r,ref} \dots +0.04$
ϵ_r range - low sens.	$-0.05 \dots \epsilon_{r,ref} \dots +0.20$
$\epsilon_{r,ref}$	1.90 ... 2.30
$\epsilon_{r,ref}$ for fresh mineral oils	typ 2.00
process temperature range	$-10 \dots +60 \text{ }^\circ\text{C}$
process connection	thread G $\frac{3}{4}$ "
pressure resistance	20 bar
protection class	IP 68
weight (without cable)	approx. 0.15 kg

BASIC FEATURES

Easily fitted, the QOS-35 will continuously monitor, measure and report actual oil condition with absolute accuracy and reliability. A simple analogue voltage output fits into your existing monitoring systems.

It works with any oil type, mineral/synthetic, and can be fitted to any engine, gearbox, hydraulic or electrical transformer system while in full operation. The unique oil condition monitoring technology ensures any wear and/or contamination is instantly detected, measured and reported.

Helping you prevent unnecessary breakdowns, eliminate unnecessary maintenance and reduce your operating costs.

Relative permittivity is a parameter that universally indicates the quality and type of oil. Any change in oil quality (presence of abrasion particles or water) will result in an increase in relative permittivity or in some cases also decrease. Sensor can react to both changes.

To successfully start oil quality monitoring, the sensor needs to be set up with an initial sample of **reference** (clean) **oil**.

DIMENSIONAL DRAWING

QOS-35

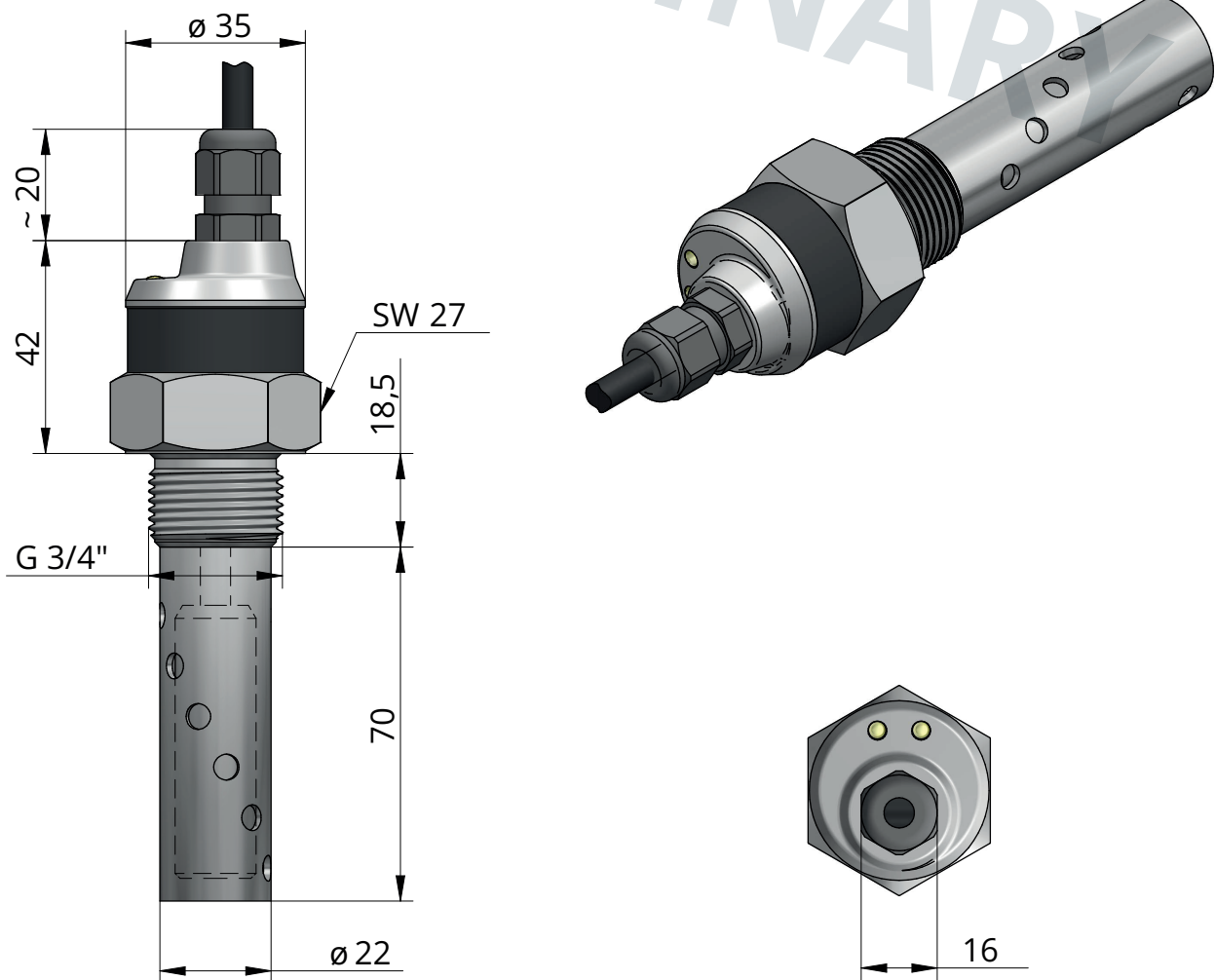

ELECTRICAL CONNECTION

The positive pole of the supply voltage (+U) is connected to the brown wire BN or pin connector no.1, the negative pole (0 V) is connected to the blue wire BU or pin connector no. 3 and output voltage (U_{out}) to the black wire BK or pin connector no. 4.

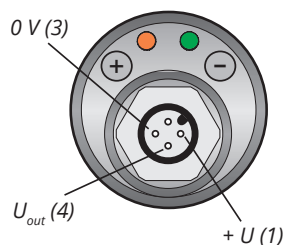
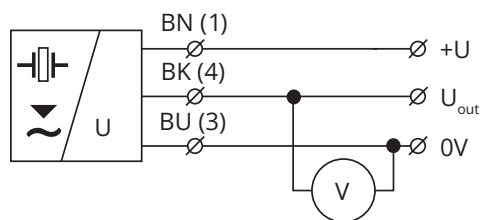

Legend:

(1...) – terminal numbers
connector sockets
BN – brown
BU – blue
BK – black

SETTINGS

The sensor can be set to LOW or HIGH sensitivity. The last setting is valid.

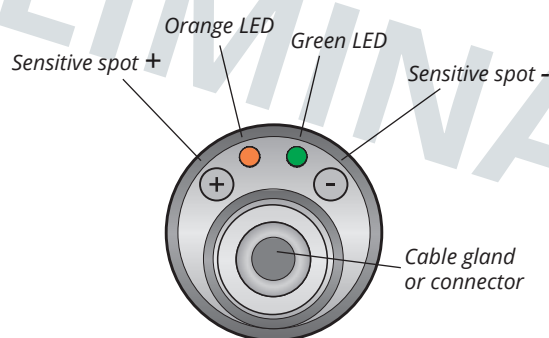

Setting the device is done after its installation by touching the magnetic pen to sensitive spots \ominus and \oplus . The setting process is indicated by the orange LED "STATE". Connect the level meter to the power supply. Using a measuring device or associated device, check its output - current or voltage.

PROCEDURE FOR SETTINGS LOW SENSITIVITY

1. Flood the electrode of the sensor to REFERENCE OIL.
2. Touch the magnetic pen for **min. 1 seconds** on the sensitive spot \ominus of the sensor.
3. Then put away the magnetic pen from sensitive spot and the LED indicator "STATE" will briefly flash 3x to confirm the setting of the sensitivity.

OUTPUT VOLTAGE	DIELECTRIC CONSTANT*
0 V	$\epsilon_{r.ref} -0.05$ (USED OIL)
2 V	$\epsilon_{r.ref}$ of REFERENCE OIL
10 V	$\epsilon_{r.ref} +0.20$ (USED OIL)

* $\epsilon_{r.ref}$ dielectric constant (rel. permittivity) for fresh mineral oils

PROCEDURE FOR SETTINGS HIGH SENSITIVITY

1. Flood the electrode of the sensor to REFERENCE OIL.
2. Touch the magnetic pen for **min. 1 seconds** on the sensitive spot \oplus of the sensor.
3. Then put away the magnetic pen from sensitive spot and the LED indicator "STATE" will briefly flash 3x to confirm the setting of the sensitivity.

OUTPUT VOLTAGE	DIELECTRIC CONSTANT*
0 V	$\epsilon_{r.ref} -0.01$ (USED OIL)
2 V	$\epsilon_{r.ref}$ of REFERENCE OIL
10 V	$\epsilon_{r.ref} +0.04$ (USED OIL)

ORDER CODE

QOS-35

PERFORMANCE

N non-explosion areas

PROCESS CONNECTION

G3/4 pipe thread G 3/4"

OUTPUT TYPE

U voltage (0 ... 10 V)

CONNECTION METHOD

B plastic threaded cable gland

C connector (socket not included with sensor, recommended type)

H plastic cable gland for protective hose



CABLE

K cable length in m (not compatible with connection method C)

QOS-35 N - G3/4 - U - B - K10

EXAMPLE OF CODING

ACCESSORIES

magnetic pen (1 pc)	included in the price	MP-8	
O-ring (NBR, EPDM, FPM/Viton), (1 pc)	included in the price		
cable over 2 m	at extra cost		
connecting connector M12	at extra cost	ELWIKA, ELKA	

Dinel, s.r.o.

U Tescomy 249, 760 01 Zlín, Czech Republic

tel.: +420 577 002 000

email: sale@dinel.cz

www.dinel.cz

version:
02/2025