



HIGH-FREQUENCY LIMIT LEVEL SENSOR RFLS-24

CE

CONTENTS

| | |
|--|----|
| 1. Basic Description | 5 |
| 2. Variants od sensors | 5 |
| 3. Dimensional Drawings | 6 |
| 4. Putting into operattion..... | 6 |
| 5. Electrical Connection | 7 |
| 6. Adjusting and Signaling Elements..... | 8 |
| 7. Status Signaling | 9 |
| 8. Settings..... | 10 |
| 8.1. Basic Setting with the Presence of Medium with Magnetic Pen | 11 |
| 8.2. Basic Setting with the Presence of Medium with DSU-1222-AP Unit | 12 |
| 8.3. Quick Setting Without the Presence of Medium with Magnetic Pen..... | 13 |
| 8.4. Quick Setting Without the Presence of Medium with DSU-1222-AP Unit..... | 14 |
| 9. Mechanical Installation | 15 |
| 10. Order Code | 17 |
| 11. Recommended Power Supply and Display Unit | 18 |
| 12. Accessories | 18 |
| 13. Safety, Protection and Compatibility | 19 |
| 14. Use, Manipulation and Maintenance | 19 |
| 15. Decommissioning or Disposal..... | 20 |
| 16. General Conditions and Warranty..... | 20 |
| 17. Marking of Labels..... | 21 |
| 18. Technical Parameters..... | 22 |
| 19. Packaging, Transport and Storage..... | 23 |

SYMBOLS USED

To ensure maximum safety in the control processes, we have defined the following safety and information instructions. Each instruction is marked with a corresponding pictogram.



Warning, caution, danger

This symbol indicates particularly important instructions for installation and operation of the device or dangerous situations that may arise during installation and operation. Failure to observe these instructions may cause malfunction, damage or destruction of the device or cause injury to health.



Information

This symbol draws attention to particularly important device characteristics and recommendations.



Note

This symbol indicates useful additional information.

SAFETY



All operations described in this instruction manual must be performed only by trained personnel or an authorized person. Warranty and post-warranty repairs must be carried out exclusively by the manufacturer.

The product cannot be used in cases where its failure or malfunction could result in major material damage, damage to health or danger to life.

Incorrect use, installation or adjustment of the sensor can lead to accidents in the application (overfilling of the tank or damage to system components).

The manufacturer is not responsible for incorrect use, loss of work caused by either direct or indirect damage and expenses incurred during installation or use of the sensor.

1. BASIC DESCRIPTION

The **RFLS-24 high-frequency level sensor** is designed for industrial use for limit level sensing of liquid and paste media. The high-frequency level sensor can be a direct replacement for a vibrating fork level switch, or for a capacitive level sensor in the case of more demanding applications. The media can be electrically conductive or non-conductive. It can be installed in metal or plastic tanks, filling containers, sumps, etc.

The sensor operates in the high-frequency band, which enables reliable detection of the medium level and eliminates deposits or foam on the electrode. The sensor suppresses the effect of deposits of viscous media (ketchups, yoghurts, mayonnaises, pâtés, syrups, jams, creams, soaps) as well as electrically conductive adhering media (cleaning agents, lyes, chemicals).

The sensors can be set for:

- simple detection of the presence of a medium (medium / air)
- distinction of the interface of two media (medium 1 / medium 2), e.g. water / oil

The sensor is made of a stainless steel housing with a sensing electrode at one end and a cover with electrical connections at the other end. The sensors are only manufactured for non-explosive areas.

2. VARIANTS OF SENSORS

| VARIANTS | |
|--------------------|--|
| Name | Type |
| RFLS-24_-1-_-_-CP | insulated electrode (PEEK) , for sensing various liquids, slurries and pastes, also suitable for oils. Plastic connector with LED indication allows setting even with a magnetic pen and visual inspection of sensor functionality |
| RFLS-24_-11-_-_-CP | insulated electrode (PEEK) with extended electrode part , for sensing various liquids, slurries and pastes, also suitable for oils. Plastic connector with LED indication allows setting even with a magnetic pen and visual inspection of sensor functionality |
| RFLS-24_-1-_-_-CM | insulated electrode (PEEK) , for sensing various liquids, slurries and pastes, also suitable for acids or bases. The durable stainless steel connector version (without LED indication) is designed for more demanding conditions, setting using a programming cable |
| RFLS-24_-11-_-_-CM | insulated electrode (PEEK) extended electrode part , for sensing various liquids, slurries and pastes, also suitable for acids or bases. The durable stainless steel connector version (without LED indication) is designed for more demanding conditions, setting with a programming wire |

3. DIMENSIONAL DRAWINGS

RFLS-24N-1-_-_-

RFLS-24N-11-_-_-

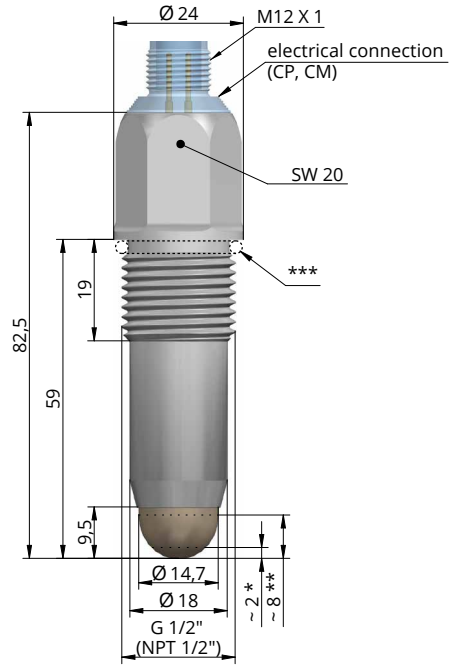
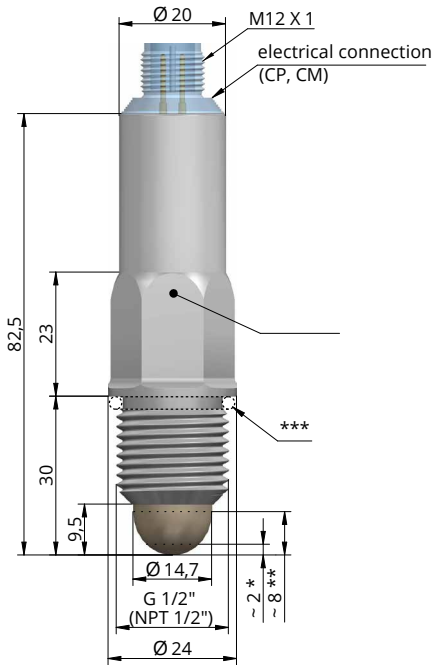

* Typical switch point position for water (factory setting)

** Typical switch point position for oil (factory setting)

*** Supplied without outer gasket as standard.

4. PUTTING INTO OPERATION

This procedure has the following three steps:

- **MECHANICAL INSTALLATION** - CHAPTER 9
- **ELECTRICAL CONNECTION** - CHAPTER 5
- **SETTING** - CHAPTER 8

5. ELECTRICAL CONNECTION

RFLS-24 sensors are connected to the evaluation units or binary outputs of PLC by a cable via a standard M12 connector.

Sensors with PNP output type can only be loaded with resistive or inductive loads. Capacitive loads and loads with low quiescent resistance (light bulb) can be evaluated by the sensor as a short circuit.

The connection diagram is shown in the figure below.

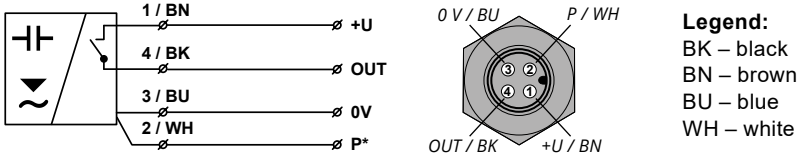

Fig. 1: Connection of RFLS-24 sensor with PNP output type

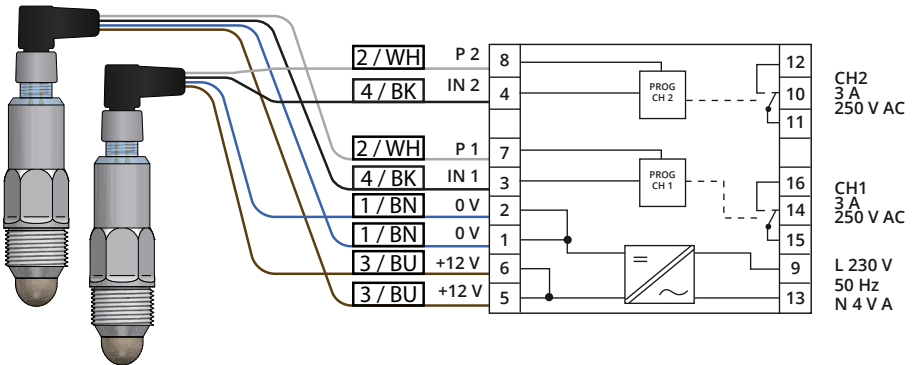

Fig. 2: Connecting the RFLS-24 sensor to the DSU-1222-AP power supply and display unit



The power supply must be designed as a stabilized low-voltage safe voltage source with galvanic isolation. In the case of using a switched-mode power supply, its design must effectively suppress common mode interference on the secondary side. If the switched-mode power supply is equipped with a PE protective terminal, it must be grounded!



Electrical connection can only be made in a voltage-free state!



If the level meter (sensor) is located outdoors at a distance greater than 20 m from an outdoor switchboard or from an enclosed building, the electrical supply to the level meter (sensor) must be supplemented with appropriate surge protection.

In the case of strong ambient electromagnetic interference, the supply cable runs alongside a power line, or its length exceeds 30 m, we recommend using a shielded cable and grounding its shielding on the source side.

6. ADJUSTING AND SIGNALING ELEMENTS

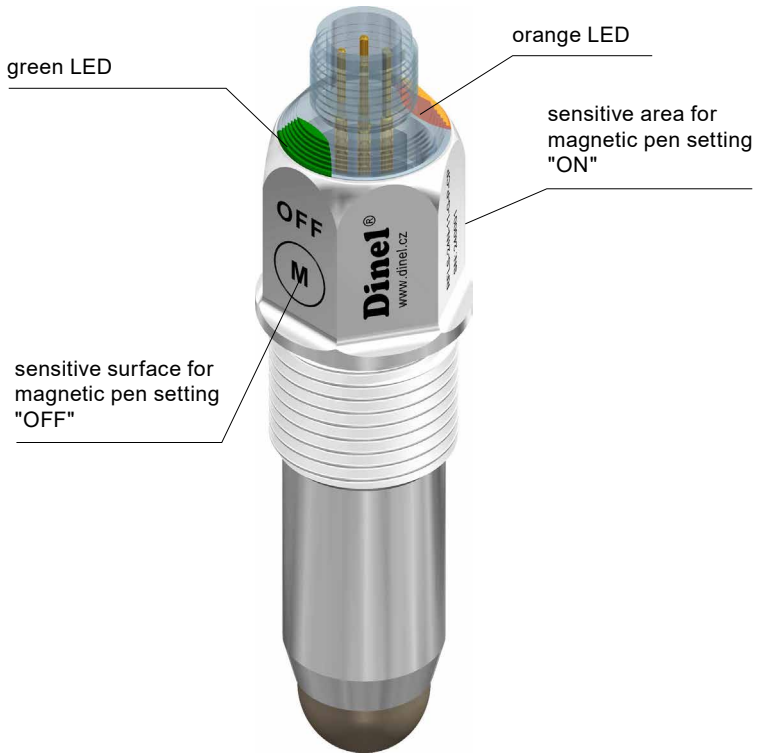

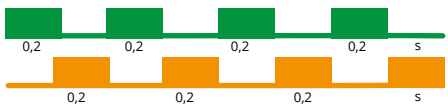

Fig. 3: Position of adjustment and display elements on the sensor (CP version)



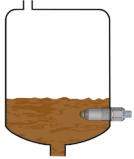



Fig. 4: CM version without adjustment and display elements





7. STATUS SIGNALING

| function | indication on the sensor |
|---|--|
| <p>normal operation sensor open</p> |  |
| <p>normal operation sensor closed</p> |  |
| <p>incorrect setting</p> |  |

8. SETTINGS

The sensor can be set in the switching mode "mode O" or in the breaking mode "mode C".

| | level | mode | output status | orange LED* |
|-----------------------|---|------|---------------|--|
| minimum level sensing |  | O | ON |  (lit) |
| |  | O | OFF |  (not lit) |

| | level | mode | output status | orange LED* |
|-----------------------|---|------|---------------|--|
| maximum level sensing |  | C | ON |  (lit) |
| |  | C | OFF |  (not lit) |

*LED indication only for CP variant, not for CM



The sensor retains settings even during a power outage

The sensitivity and switching mode of the RFLS-24 sensor can be set:

- 1) **locally using a magnetic pen (CP version with plastic connector and indication)**, which is attached to the magnetically sensitive ON or OFF pads on the sensor
- 2) **remotely via a setting wire using the DSU-1222-AP power supply unit (all versions)**. Remote parameterization allows the same setting options as setting with a magnetic pen.

8.1. BASIC SETTINGS

WITH MEDIUM WITH A MAGNETIC PEN

(only CP version with plastic connector and indication)

To set the sensitivity and switching mode, when it is possible to flood and flush the sensor with the medium. With this setting, the sensor eliminates the presence of deposits and foam on the electrode.

a) Setting mode O (switches on when flooded)

1. Immerse the sensor electrode in the measured medium (in case of detection of the interface of two media, place the electrode in the lower medium).
2. Place the magnetic pen for 2 - 4 sec on the sensitive surface of the ON sensor until both LEDs light up and then remove the magnetic pen. The sensor is set and the orange LED flashes three times.
3. Remove the sensor from the medium (in case of detection of the interface of two media, place the electrode in the upper medium). Leave any deposits on the electrode.
4. Place the magnetic pen for 2 - 4 sec on the sensitive surface of the OFF sensor until both LEDs light up and then remove the magnetic pen. The sensor is set and the orange LED flashes three times.

Check the status of the indicators: If the orange LED is off and the green LED is flashing, the sensor is set correctly.

If the orange and green LEDs flash alternately, the sensor did not recognize the difference between the flooded and the drained state. Repeat the setting!

b) Setting mode C (opens when flooded)

1. Immerse the sensor electrode in the measured medium (in case of detection of the interface of two media, place the electrode in the lower medium).
2. Place the magnetic pen for 2 - 4 sec on the sensitive surface of the OFF sensor until both LEDs light up and then remove the magnetic pen. The sensor is set and the orange LED flashes three times.
3. Remove the sensor from the medium. (in case of detection of the interface of two media, place the electrode in the upper medium). Leave any deposits on the electrode.
4. Place the magnetic pen for 2 - 4 sec on the sensitive surface of the ON sensor until both LEDs light up and then remove the magnetic pen. The sensor is set and the orange LED flashes three times.

Check the status of the indicators: If the orange LED is on and the green LED is flashing, the sensor is set correctly.

If the orange and green LEDs flash alternately, the sensor has not recognized the difference between the flooded and the drained state.

8.2. BASIC SETTINGS

WITH MEDIUM WITH DSU-1222-AP UNIT

(all versions)

To set the sensitivity and switching mode, when it is possible to flood and flush the sensor with the medium. With this setting, the sensor eliminates the presence of deposits and foam on the electrode.

a) Setting mode O (switches on when flooded)

1. Set the SET CH1 switch (to set the sensor connected to channel 1) or SET CH2 switch (to set the sensor connected to channel 2) or SET CH1 and SET CH2 switch to ON for simultaneous setting of both sensors.
2. Immerse the sensor electrode in the measured medium (if an interface between two media is detected, place the electrode in the lower medium).
3. Set the SET switch to ON.
4. Press the SETTING button for 1 - 3 sec After approx. 2 sec the orange LED on the unit will flash three times, now release the SETTING button.
5. Remove the sensor from the medium (if an interface between two media is detected, place the electrode in the upper medium). Leave any deposits on the electrode.
6. Set the SET switch to OFF.
7. Press the SETTING button for 1 - 3 sec After approx. 2 sec the orange LED on the unit will flash three times, now release the SETTING button.

b) Setting mode C (opens when flooded)

1. Set the SET CH1 switch (to set the sensor connected to channel 1) or SET CH2 switch (to set the sensor connected to channel 2) or SET CH1 and SET CH2 switch to ON position to set both sensors simultaneously.
2. Immerse the sensor electrode in the measured medium (if an interface between two media is detected, place the electrode in the lower medium).
3. Set the SET switch to OFF position.
4. Press the SETTING button for 1 - 3 sec After approx. 2 sec the orange LED on the unit will flash three times, now release the SETTING button.
5. Remove the sensor from the medium (if an interface between two media is detected, place the electrode in the upper medium). Leave any deposits on the electrode.
6. Set the SET switch to ON position.
7. Press the SETTING button for 1 - 3 sec After approx. 2 sec the orange LED on the unit will flash three times, now release the SETTING button.

8.3. QUICK SETTINGS

WITHOUT MEDIUM WITH A MAGNETIC PEN

(only CP version with plastic connector and indication)

This mode is only suitable for verifying the sensor before commissioning in case the measured medium is not available. This setting can be used for sensing non-adherent water-based media.

a) Setting mode O (switches on when flooded) using a magnetic pen

1. The sensor is turned with the measuring electrode into free space.
2. Place the magnetic pen for 5 - 10 sec on the sensitive surface of the ON sensor (first both LEDs light up, after approx. 3 sec the orange LED flashes three times and after another approx. 2 sec the orange LED flashes three times again - now the magnetic pen can be moved away).

The sensor is now set to mode O (switches on when flooded).

b) Setting mode C (opens when flooded) using a magnetic pen

1. The sensor is turned with the measuring electrode into free space.
2. Place the magnetic pen for 5 - 10 sec on the sensitive surface of the OFF sensor (first both LEDs light up, after approx. 3 sec the orange LED flashes three times and after another approx. 2 sec the orange LED flashes three times again - now the magnetic pen can be moved away).

The sensor is now set to mode C (opens when flooded).

8.4. QUICK SETTINGS

WITHOUT MEDIUM WITH DSU-1222-AP UNIT

(all versions)

The RFLS-24 sensor can be set using a programming wire or a special evaluation unit DSU-1222-AP. The evaluation and power supply unit DSU-1222-AP is designed to connect one or two RFLS-24 sensors.

This mode is only suitable for verifying the sensor before commissioning if the measured medium is not available. This setting can be used for sensing non-adherent water-based media.

a) Setting mode O (switches on when flooded) using the DSU-1222-AP unit

1. Set the SET CH1 switch (for setting the sensor connected to channel 1) or SET CH2 (for setting the sensor connected to channel 2) or SET CH1 and SET CH2 to set both sensors simultaneously to the ON position.
2. The sensor is turned with the measuring electrode into free space.
3. Set the SET switch to the OFF position.
4. Press the SETTING button. After approx. 2 sec the orange LED on the unit flashes three times, after a further approx. 3 sec the orange LED flashes three times again, now release the SETTING button.
5. Set the SET CH1 or SET CH2 switch to the OFF position.

The sensor is now set to mode O (switches on when flooded).

b) Setting mode C (opens when flooded) using the DSU-1222-AP unit

1. Set the SET CH1 switch (for setting the sensor connected to channel 1) or SET CH2 (for setting the sensor connected to channel 2) or SET CH1 and SET CH2 to set both sensors simultaneously to the ON position.
2. The sensor is turned with the measuring electrode into free space.
3. Set the SET switch to the ON position.
4. Press the SETTING button. After approx. 2 sec the orange LED on the unit flashes three times, after a further approx. 3 sec the orange LED flashes three times again, now release the SETTING button.
5. Set the SET CH1 or SET CH2 switch to the OFF position.

The sensor is now set to mode C (opens when flooded).



For safety reasons, we recommend setting the "O" mode for minimum level sensing (the sensor switches on when flooded). A sensor or wiring failure will be reflected in the same way as a level emergency by opening the sensor. Similarly, for maximum level sensing, we recommend setting the "C" mode (the sensor switches on when flooded).



Unless otherwise agreed, mode "O" is set on all sensors from the factory.



When using the "quick setup" function, the sensor does not eliminate the presence of deposits and foam on the electrode. The manufacturer recommends performing the Basic Setup at the earliest possible opportunity.

9. MECHANICAL INSTALLATION

RFLS-24 level sensors can be mounted horizontally or obliquely in the shell of a vessel, tank or pipe by screwing into a weld-on fitting or by fastening with a nut. Basic application recommendations are given below.

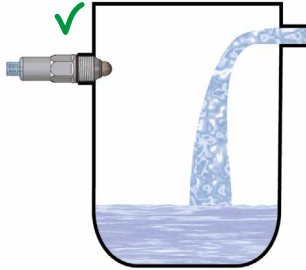

Fig. 5: Correct orientation of sensor installation in tanks

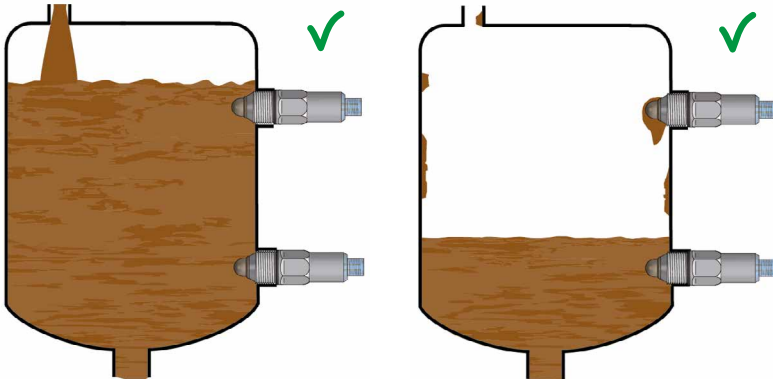

Fig. 6: Lateral installation of sensors in a tank with a viscous medium



When mounted in a metal tank or container, it is not necessary to separately ground the sensor housing.



In the case of sensing aggressive media, it is necessary to check the chemical resistance of the materials from which the sensor is made (see the table Material design on page 22). Any chemical damage is not covered by the warranty.



In the case of placement in a tank at the medium inlet, installation is required out of reach of the filling flow.

It is recommended to install the sensors in horizontal pipes diagonally from the side.

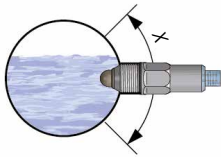

X = Recommended orientation for installing sensors in the pipe

When installing the sensor vertically in a pipe, be careful of the possible formation of an air pocket or adhering liquid residues at the bottom of the pipe.

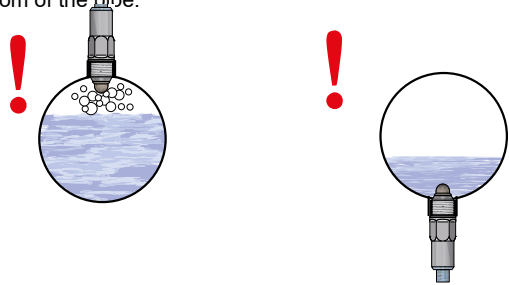

Fig. 7: Installing the sensor in the pipe

When mounting in the side wall, long nozzles should be avoided, where viscous media could be retained. We recommend mounting the sensor so that the entire measuring electrode is inside the vessel.

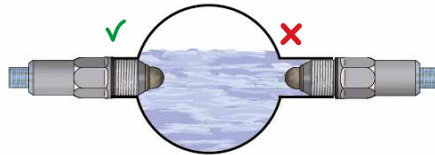

Fig. 8: Correct and incorrect installation of the sensor into the pipe weld

Sensor installation for reliable control of liquid level with foam on the surface. The sensitivity of the sensor can be set to detect the liquid-foam interface. After the liquid level drops, the sensor does not respond to foam deposits on the electrode.

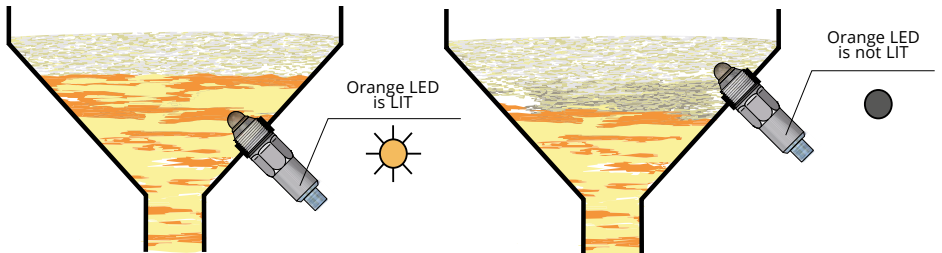

Fig. 9: Monitoring the foaming medium level



When mounted in a metal tank or container, it is not necessary to separately ground the sensor housing.



In the case of sensing aggressive media, it is necessary to check the chemical resistance of the materials from which the sensor is made (see tab. Material design on page 22). The warranty does not cover any chemical damage.



Fig. 10: Examples of installing sensors in a tank

10. ORDER CODE

| ORDER CODE | |
|------------|--|
| RFLS-24 | |
| | PERFORMANCE N non-explosive areas |
| | ELECTRODE TYPE 1 coated electrode (PEEK) 11 coated electrode (PEEK) - extended electrode section |
| | PROCESS CONNECTION* G front installation, thread G ½ NPT front installation, thread NPT ½ |
| | OUTPUT TYPE P PNP (open collector) |
| | ZPŮSOB ELEKTRICKÉHO PŘIJOJENÍ CP standard plastic connector, thread M12 (LED indication) CM standard stainless steel connector, thread M12 (hardened variant) |
| | RFLS-24 N - 11 - G - P - CP EXAMPLE OF CODING |

* Supplied without outer gasket as standard.

11. RECOMMENDED POWER SUPPLY AND DISPLAY UNIT

| | | | |
|---|---------------|-------------|---|
| power supply of sensors, conversion of their state to a power contact and remote parameterization | at extra cost | DSU-1222-AP |  |
|---|---------------|-------------|---|

12. ACCESSORIES

| | | | |
|--|---------------|------------------------------|---|
| magnetic pen (1 pc) (CP variant only) | included | MP-8 |  |
| detachable connector | at extra cost | M12 CONNECTOR ELKA 4012 |  |
| detachable connector | at extra cost | M12 CONNECTOR ELWIKA 4012 |  |
| cable with M12 connector three-core without programming wire option | at extra cost | M12 CONNECTOR KV 4312 |  |
| cable with M12 connector four-core with programming wire option | at extra cost | M12 CONNECTOR (KV 4412) |  |
| various types of seals: o-rings (EPDM, FPM, NBR) USIT rings (FPM, NBR) aluminum seals | at extra cost | |  |
| weld flange G 1/2 | at extra cost | |  |
| Fixing stainless steel nut G 1/2 | at extra cost | |  |

13. SAFETY, PROTECTION AND COMPATIBILITY

The level sensor is equipped with protection against fault voltage on the electrode, reverse polarity, short-term overvoltage and current overload at the output.

The product cannot be used in cases where its failure or malfunction could result in major material damage, damage to health or danger to life.

Protection against dangerous contact is ensured by a low safety voltage according to EN 33 2000-4-41. EMC is ensured by compliance with the standards EN 55011/B, EN 61326-1, EN 61000-4-2 to -6 and -8.

A declaration of conformity has been issued for this device in accordance with Act 90/2016 Coll. and subsequent amendments. The supplied electrical equipment meets the requirements of the applicable government regulations on safety and electromagnetic compatibility.

14. USE, MANIPULATION AND MAINTENANCE

The sensor does not require any operator assistance for operation. Maintenance of the device consists of checking the integrity of the sensor and the power cable. Cleaning or sterilization of the sensor (CIP/SIP) is possible under the conditions specified in the technical parameters.



It is forbidden to make any changes or interventions on the RFLS–24 sensor without the consent of the manufacturer. Any repairs must be carried out only by the manufacturer or a service organization authorized by him.

The assembly, installation, commissioning, operation and maintenance of the RFLS–24 sensor must be carried out in accordance with these instructions and the provisions of the valid standards for the installation of electrical equipment must be observed.

Operation during operation:

- If the sensor is connected to an automatic control system or to an emergency alarm system, its settings must not be interfered with in any way during operation.
- If it is necessary to change the sensor settings, the entire system must be temporarily shut down and the process kept in a safe state using other means and measures.
- The signaling of fault conditions is described in the chapters Signaling of statuses.

Operation in the event of a fault

- In the event of faults or fault signals detected, the entire system must be shut down and the process kept in a safe state using other means and measures.
- If the fault requires the sensor to be replaced, the manufacturer must be notified (including a description of the fault).

Sensor repairs:

- If it is necessary to send the sensor for repair, proceed as follows:
- Dismantle and clean the sensor, decontaminate it if necessary and pack it well.
- Write down the most detailed description of the fault, also attach a detailed description of the application and installation location and send everything together with the sensor to the address of Dinel, s.r.o.

We ask for your maximum cooperation in finding the root cause of the problem. Your satisfaction is our priority!

15. DECOMMISSIONING OR DISPOSAL

Dismantling:

Before starting disassembly, consider possible risks such as tank pressure, high temperatures, corrosive properties or toxicity of products, etc.

Read the product manual, chapters "Commissioning procedure" and "Electrical connection" and perform the steps in reverse order.

Disposal:

The RFLS-24 high-frequency limit level sensors are composed of materials that can be recycled by specialized companies. Mark the device as waste and dispose of it according to the relevant government regulations for the management of electronic waste. Materials: see "Technical parameters".

16. GENERAL CONDITIONS AND WARRANTY

The manufacturer guarantees that this product will have the specified properties specified in the technical conditions for a period of 3 years from the date of delivery.

The manufacturer is responsible for defects that were detected during the warranty period and were complained about in writing.

The warranty does not apply to defects caused by incorrect handling or failure to comply with the technical conditions.

The warranty expires if the customer or a third party makes changes or modifications to the product, if the product is mechanically or chemically damaged, or if the serial number is illegible.

To make a complaint, it is necessary to present the warranty certificate.

In the event of a justified complaint, we will repair the defective product or replace it with a new one. In both cases, the warranty period is extended by the repair period.

17. MARKING OF LABELS

The marking is made by laser engraving on the sensor body
Data on the RFLS-24N-_-_-_-CM series sensors

Dinel[®]
www.dinel.cz

RFLS-24N-1-G-P-CM
SN:240000



Data on the RFLS-24N-_-_-_-CP series sensors



Dinel[®]
www.dinel.cz

RFLS-24N-11-G-P-CP
SN:240000



Description:

Manufacturer's brand: Dinel[®] logo

Internet address: www.dinel.cz

Sensor type: RFLS-24N-_-_-_-

Product serial number: SN: _____ - (from left: year of manufacture, serial number)

Protection: IP68

Conformity mark: CE

Electronic waste collection sign: 

18. TECHNICAL PARAMETERS

BASIC TECHNICAL DATA

| | |
|---|------------------------|
| Supply voltage | 7 ... 34 V DC |
| Current consumption | max. 5 mA DC |
| Output type | PNP (open collector) |
| Max. switching current (PNP output) | 300 mA |
| Operating temperature range at the process connection point | -40 ... +105 °C |
| Maximum overpressure | -1 ... 100 bar |
| Residual voltage in the switched state | max. 1,5 V |
| Separation capacity (housing - leads) / dielectric strength | 4nF / 500 V AC (50 Hz) |
| Protection | IP 68 |
| Weight (without cable) | aprox. 0,15 kg |
| Minimum relative permittivity | $\epsilon_r = 1,5$ |
| Minimum distance of the electrode from the vessel wall | 20 mm |

MATERIAL DESIGN

| sensor part | | standard material * |
|----------------------|------------|--|
| Head (case) | | stainless steel W.Nr. 1.4404 (AISI 316L) |
| M12 connector | version CP | polycarbonate |
| | version CM | stainless steel W.Nr. 1.4404 (AISI 316L) |
| Electrode insulation | | PEEK |

* Verify chemical compatibility with the medium. Other material types can be selected upon agreement.

PROCESS CONNECTION

| name | dimension | marking |
|-------------|-----------|---------|
| Pipe thread | G ½ | G |
| NPT thread | NPT ½ | NPT |

MECHANICAL DESIGN AND SPACE CLASSIFICATION

| sensor design | equipment classification |
|---------------|---|
| RFLS-24N | Basic design for use in non-explosive environments. |

FACTORY SETTINGS

| | |
|----------------|------------------------------|
| Switching mode | O (switches on when flooded) |
| Sensitivity | for water sensing |

TEMPERATURE AND PRESSURE RESISTANCE – version N

| variants | temperature t_p | temperature t_a | maximum overpressure |
|-----------------|--------------------|--------------------|----------------------|
| RFLS-24N-_-_-_- | -40 °C ... +75 °C | -40 °C ... +75 °C | 100 bar |
| RFLS-24N-_-_-_- | +75 °C ... +105 °C | +75 °C ... +105 °C | 50 bar |

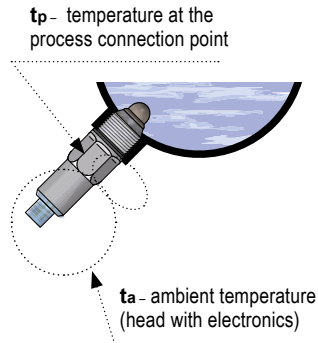

19. PACKAGING, TRANSPORT AND STORAGE

The RFLS–24 device is packed in a polyethylene bag and the entire shipment is placed in a cardboard box. The cardboard box is filled with suitable padding to prevent mechanical damage during transport.

Remove the device from the packaging only before use, to prevent possible damage.

Transport to the customer is carried out by a forwarding company. After prior arrangement, personal collection of the ordered goods at the company's headquarters is also possible. Upon receipt, please check whether the shipment is complete

and corresponds to the scope of the order, or whether the packaging and device were not damaged during transport. Do not use a device that is obviously damaged during transport, but contact the manufacturer to resolve the situation.

If the device is to be transported further, then only packed in the original packaging and protected against shocks and weather conditions.

Store the device in its original packaging in dry areas, protected from weather conditions, with humidity up to 85% without the effects of chemically active substances. The storage temperature range is -10 °C to +50 °C.

Dinel[®]

process control

Dinel, s.r.o.
U Tescomy 249
760 01 Zlín
Czech Republic

Phone: +420 577 002 002
E-mail: sale@dinel.cz

www.dinel.cz

The manufacturer reserves the right to change product specifications and appearance without prior notice.

The current version of the manual can be found at www.dinel.cz

version: 03/2025



QMS
ISO 9001

